

**RAPIDUS**

Power Factor  
Controller

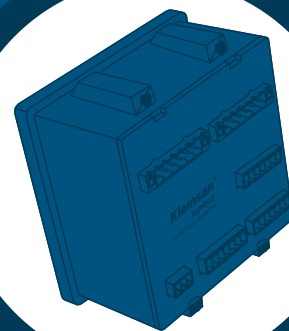
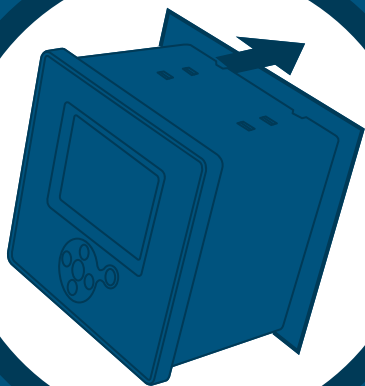

**USER  
MANUAL**

**Klemsan<sup>®</sup>**

## TABLE OF CONTENTS

<b>SECTION 1</b>	<b>GENERAL INFORMATION .....</b>	<b>10</b>
1.1	Symbols .....	10
1.2	General Warnings .....	10
1.3	Receipt Control and Contents of the Delivery .....	12
1.4	RAPIDUS Reactive Power Control Relay .....	13
1.5	RAPIDUS Front Panel .....	14
1.6	Four-Quadrant Representantion .....	17
<b>SECTION 2</b>	<b>INSTALLATION .....</b>	<b>19</b>
2.1	Preparation for Installation .....	19
2.2	Placing on the panel.....	19
2.3	Wiring Diagrams .....	22
2.4	Dimensions .....	23
<b>SECTION 3</b>	<b>MENUS .....</b>	<b>25</b>
3.1	“First Power-on” Settings .....	25
3.1.1	Dil / Lang. / Язык Setting .....	25
3.1.2	Date .....	26
3.1.3	Time .....	27
3.1.4	Current Transformer Ratio (CTR) .....	27
3.1.5	Voltage Transformer Ratio (VTR) .....	29
3.1.6	Step number .....	29
3.1.7	Restart.....	30
3.2	Startup Screen .....	30
3.2.1	Settings .....	31
3.2.1.1	Quick setup Menu .....	32
3.2.1.1.1	Language Setting .....	32
3.2.1.1.2	Date Menu .....	32
3.2.1.1.3	Time Menu .....	32
3.2.1.1.4	CTR.....	32
3.2.1.1.5	VTR.....	32
3.2.1.1.6	Step number .....	32
3.2.1.2	Setup Menu .....	33
3.2.1.2.1	Network Menu.....	34
3.2.1.2.1.1	CTR Setting .....	34
3.2.1.2.1.2	VTR Setting .....	35
3.2.1.2.1.3	Demand period setting .....	35
3.2.1.2.2	Step Menu.....	36
3.2.1.2.2.1	Ent. Power Menu.....	36
3.2.1.2.2.2	Ent. Type Menu.....	36
3.2.1.2.2.3	Predefined Menu .....	37
3.2.1.2.2.3.1	Structure Menu .....	38
3.2.1.2.2.3.2	Power Menu .....	38
3.2.1.2.2.3.3	Number Menu .....	38
3.2.1.2.2.4	Other Menu .....	39

3.2.1.2.3	Compensation Menu .....	39
3.2.1.2.3.1	Steps Menu .....	39
3.2.1.2.3.2	Program Menu.....	40
3.2.1.2.3.2.1	Rapidus Program .....	41
3.2.1.2.3.2.2	Ascending Sequential program .....	41
3.2.1.2.3.2.3	Descending Sequential Mode .....	43
3.2.1.2.3.2.4	Linear Mode.....	45
3.2.1.2.3.2.5	Circular Mode.....	47
3.2.1.2.3.2.6	Manual program .....	49
3.2.1.2.3.3	Target 1 Menu.....	50
3.2.1.2.3.4	Target 2 Menu.....	50
3.2.1.2.3.5	Target Low Lim. Menu .....	50
3.2.1.2.3.6	Target High Lim. Menu .....	50
3.2.1.2.3.7	Activation Time Menu.....	51
3.2.1.2.3.8	Deactivation Time Menu.....	51
3.2.1.2.3.9	Shift Angle Menu .....	51
3.2.1.2.3.10	Averaging Time .....	52
3.2.1.2.3.11	Fixed Steps Menu .....	52
3.2.1.2.4	Learn Menu.....	52
3.2.1.2.4.1	Learn Conn. Menu .....	53
3.2.1.2.4.1.1	Learn at start .....	53
3.2.1.2.4.1.2	Step number .....	54
3.2.1.2.4.1.3	Retry Timer.....	54
3.2.1.2.4.1.4	Retry Number .....	55
3.2.1.2.4.2	Learn Step Menu.....	55
3.2.1.2.4.2.1	Learn at start .....	56
3.2.1.2.4.3	Aux. Input Menu .....	56
3.2.1.2.4.4	Off mode.....	56
3.2.1.2.4.5	Night/Day Mode .....	56
3.2.1.2.4.6	Generator Mode.....	57
3.2.1.2.5	Device Menu .....	57
3.2.1.2.5.1	Language Setting .....	58
3.2.1.2.5.2	Contrast Setting .....	58
3.2.1.2.5.3	Pass. Protection .....	58
3.2.1.2.5.4	New Password Setting.....	59
3.2.1.2.5.5	Display On Setting .....	59
3.2.1.2.5.6	Display On Time Setting .....	59
3.2.1.2.6	Energy Menu .....	60
3.2.1.2.6.1	Start of day setting.....	60
3.2.1.2.6.2	Start of month setting .....	60
3.2.1.2.6.3	kWh Setting .....	60
3.2.1.2.6.4	kWh E. Setting.....	60
3.2.1.2.6.5	kVArh I. Setting.....	61
3.2.1.2.6.6	kVArh C. Setting .....	61
3.2.1.2.7	Communication Menu.....	61
3.2.1.2.7.1	Baud Rate Menu.....	61

3.2.1.2.7.2	Slave Id Menu.....	61
3.2.1.2.8	Alarm Menu.....	62
3.2.1.2.8.1	Energy Alarm Menu.....	62
3.2.1.2.8.2	V(L-N) Alarm Menu.....	63
3.2.1.2.8.3	V(L-L) Alarm Menu.....	65
3.2.1.2.8.4	Current Alarm Menu.....	65
3.2.1.2.8.5	P Alarm Menu.....	65
3.2.1.2.8.6	Q Alarm Menu.....	65
3.2.1.2.8.7	S Alarm Menu.....	65
3.2.1.2.8.8	CosØ Alarm Menu.....	65
3.2.1.2.8.9	PF Alarm Menu.....	65
3.2.1.2.8.10	Step Alarm Menu.....	65
3.2.1.2.8.11	IN Alarm Menu.....	66
3.2.1.2.8.12	F Alarm Menu.....	66
3.2.1.2.8.13	V Harmonics Alarm Menu.....	66
3.2.1.2.8.14	I Harmonics Alarm Menu.....	67
3.2.1.2.8.15	Temperature Alarm Menu.....	67
3.2.1.2.9	Clear Menu.....	68
3.2.1.3	Date/Time Menu.....	70
3.2.1.4	System Info Menu.....	70
3.2.1.5	Password Menu.....	71
3.2.1.6	Restart Menu.....	71
3.2.1.7	Default Settings.....	72
3.2.2	Measure Menu.....	72
3.2.2.1	Instantaneous Menu.....	73
3.2.2.2	Energy Menu.....	73
3.2.2.2.1	Imp. Active Menu (Imported Active Energy Menu).....	74
3.2.2.2.2	Exp. Active Menu (Exported Active Energy Menu).....	76
3.2.2.2.3	Ind. Reactive Menu (Inductive Reactive Energy Menu).....	76
3.2.2.2.4	Cap. Reactive Menu (Capacitive Reactive Energy Menu).....	76
3.2.2.3	Demand Menu.....	76
3.2.2.3.1	Current Menu.....	77
3.2.2.3.1.1	Act. Power Menu.....	78
3.2.2.3.1.2	Rea. Power Menu.....	78
3.2.2.3.1.3	App. Power Menu.....	78
3.2.2.4	Phasor diagram Menu.....	78
3.2.2.5	Harmonics Menu.....	79
3.2.2.5.1	Table Menu.....	79
3.2.2.5.2	Graphic Menu.....	80
3.2.3	Comp. (Compensation) Menu.....	80
3.2.3.1	Switch Count Menu.....	81
3.2.3.2	Conn. Time Menu.....	81
3.2.3.3	DCM (Dynamic Capacitor Monitoring).....	82
3.2.3.4	Learn Conn. Menu.....	82
3.2.3.5	Learned Conn. Menu.....	83
3.2.3.6	Learn Steps Menu.....	84
3.2.3.7	Learn Step Menu.....	84

3.2.4	Alarms Menu .....	84
3.2.4.1	Phase1 Menu.....	85
3.2.4.2	Phase2 Menu.....	86
3.2.4.3	Phase3 Menu.....	86
3.2.4.4	Step Menu.....	86
3.2.4.5	Other Menu .....	87
3.2.5	Analysis Menu .....	87
3.2.5.1	Minimum Menu .....	88
3.2.5.1.1	Hourly Menu.....	88
3.2.5.1.1.1	Phase1 Menu .....	88
3.2.5.1.1.2	Phase2 Menu.....	88
3.2.5.1.1.3	Phase3 Menu.....	89
3.2.5.1.1.4	Other .....	89
3.2.5.1.2	Daily Menu .....	89
3.2.5.1.3	Monthly Menu .....	89
3.2.5.2	Maximum Menu.....	89
3.2.5.3	Average Menu .....	89
3.2.5.4	Energy Menu.....	90
3.2.5.4.1	Hourly Menu.....	90
3.2.5.4.2	Daily Menu.....	90
3.2.5.4.3	Monthly Menu .....	90

## **SECTION 4 MODBUS PROTOCOL.....92**

4.1	RS485 Wiring Diagram .....	92
4.2	Computer Connection .....	92
4.3	Message Format and Data Types of MODBUS-RTU Protocol .....	93
4.4	Implemented functions for MODBUS-RTU Protocol.....	93
4.5	Data and Setting Parameters for RAPIDUS .....	94
4.5.1	Measured and Calculated Data .....	94
4.5.1.1	Readable Data for RAPIDUS 231R-E.....	95
4.5.1.1.1	Alarm Flags(RAPIDUS 231R-E).....	107
4.5.1.2	Readable Data for RAPIDUS 232R-E.....	109
4.5.1.2.1	Alarm Flags(RAPIDUS 232R-E).....	122
4.5.2	RAPIDUS Setting Parameters .....	123
4.5.2.1	Setting for RAPIDUS 231R-E .....	124
4.5.2.2	Setting Parameters for RAPIDUS 232R-E .....	129
4.5.3	ARCHIVE (HISTORY) RECORDS .....	136
4.5.3.1	Hourly archive data .....	138
4.5.3.2	Daily archive data .....	140
4.5.3.3	Monthly archive data .....	140
4.5.4	Clear(Common for RAPIDUS 231R-E and RAPIDUS 232R-E).....	141

## **SECTION 5 FACTORY PRESETS ..... 143**

## **SECTION 6 TECHNICAL SPECIFICATIONS..... 149**

## FIGURES

Fig. 1-1	RAPIDUS 231R-E.....	14
Fig. 1-2	RAPIDUS 232R-E.....	15
Fig. 1-3	RAPIDUS with 24 RELAYS .....	16
Fig. 1-4	Step Information Screen for RAPIDUS 232R-E .....	16
Fig. 1-5	Four-Quadrant Representation .....	17
Fig. 2-1	Placing RAPIDUS on the Panel.....	19
Fig. 2-2	Securing RAPIDUS .....	20
Fig. 2-3	Loosening of the Terminal Screws.....	20
Fig. 2-4	Inserting Cable into the Terminal Block .....	21
Fig. 2-5	Fixing the Cable to the Terminal Block .....	21
Fig. 2-6	RAPIDUS Connection Diagram (12 Steps) .....	22
Fig. 2-7	Rapidus Connection Diagram (24 Steps).....	22
Fig. 2-8	Dimensions.....	23
Fig. 3-1	First Operation Settings .....	25
Fig. 3-2	Dil / Lang./ Язык Setting .....	25
Fig. 3-3	Date Setting.....	26
Fig. 3-4	Date Setting Example .....	26
Fig. 3-5	Current Transformer Ratio .....	27
Fig. 3-6	Entering a Value in Virtual Keyboard .....	28
Fig. 3-7	Voltage Transformer Ratio.....	29
Fig. 3-8	Step Structure .....	29
Fig. 3-9	Restart.....	30
Fig. 3-10	Startup Screen when the Connections Are Being Learned.....	30
Fig. 3-11	Startup Screen after the Connections Are Learned .....	31
Fig. 3-12	Settings Menu.....	31
Fig. 3-13	Quick Setup Menu.....	32
Fig. 3-14	RAPIDUS Prompt for saving .....	33
Fig. 3-15	Network Menu.....	34
Fig. 3-16	Current Transformer Ratio Setting .....	34
Fig. 3-17	Voltage Transformer Ratio Setting .....	35
Fig. 3-18	Demand Period Setting.....	35
Fig. 3-19	Step Menu .....	36
Fig. 3-20	Ent. Power Menu.....	36
Fig. 3-21	Ent. Type Menu .....	37
Fig. 3-22	Predefined Menu .....	37
Fig. 3-23	Other Menu .....	39
Fig. 3-24	Compensation Menu .....	39
Fig. 3-25	Program Menu.....	40
Fig. 3-26	RAPIDUS Mode Compensation Steps .....	41
Fig. 3-27	RAPIDUS Asc. Sequential Mode .....	42
Fig. 3-28	RAPIDUS Des. Sequential Mode.....	44
Fig. 3-29	RAPIDUS Linear Mode .....	46
Fig. 3-30	RAPIDUS Circular Mode.....	48
Fig. 3-31	Manual Mode Menu .....	49
Fig. 3-32	RAPIDUS with 24 RELAYS .....	49

Fig. 3-33	Step Information Screen for RAPIDUS 232R-E .....	50
Fig. 3-34	Averaging Time Menu.....	52
Fig. 3-35	Fixed Steps Menu .....	52
Fig. 3-36	Connection Setup .....	53
Fig. 3-37	Learning Connections at the Startup.....	54
Fig. 3-38	Waiting Time After Unsuccessful Connection Learning .....	54
Fig. 3-39	Retry Timer.....	55
Fig. 3-40	Retry Count.....	55
Fig. 3-41	Learn step.....	55
Fig. 3-42	Aux. Input.....	56
Fig. 3-43	Device Menu .....	57
Fig. 3-44	Contrast Setting.....	58
Fig. 3-45	Pass. Protection .....	58
Fig. 3-46	New Password Entry.....	59
Fig. 3-47	Display On Time Setting.....	59
Fig. 3-48	Energy Menu.....	60
Fig. 3-49	Baud Rate Setting.....	61
Fig. 3-50	Slave Id Setting.....	61
Fig. 3-51	Alarm Menu .....	62
Fig. 3-52	Energy Menu.....	62
Fig. 3-53	V(L-N) Alarm Menu.....	63
Fig. 3-54	Alarm Relay Setting .....	63
Fig. 3-55	Alarm Time Setting .....	64
Fig. 3-56	Hysteresis Setting.....	64
Fig. 3-57	Alarm Example .....	64
Fig. 3-58	V Harmonics Alarm Menu.....	66
Fig. 3-59	THDV High Limit Setting.....	66
Fig. 3-60	V3-V21 Harmonics High Limit Setting .....	67
Fig. 3-61	No Alarm Time Condition .....	67
Fig. 3-62	Invalid Limit .....	68
Fig. 3-63	Clear Menu.....	68
Fig. 3-64	Before Clearing.....	69
Fig. 3-65	After Clearing.....	69
Fig. 3-66	Initial Value Entered After Clearing .....	69
Fig. 3-67	Date/Time Menu.....	70
Fig. 3-68	System Info .....	70
Fig. 3-69	Password.....	71
Fig. 3-70	RAPIDUS Restart .....	71
Fig. 3-71	Default Settings .....	72
Fig. 3-72	Measure Menu.....	72
Fig. 3-73	Instantaneous Menu .....	73
Fig. 3-74	Imp. Active Energy Page .....	74
Fig. 3-75	Hour Start Example.....	74
Fig. 3-76	Day Start Example .....	75
Fig. 3-77	Month Start Example .....	75
Fig. 3-78	Demand Menu.....	76
Fig. 3-79	Demand Example.....	77

Fig. 3-80	Current Menu.....	77
Fig. 3-81	Phasor Diagram Menu.....	79
Fig. 3-82	Harmonics Table Menu.....	79
Fig. 3-83	Graphic Menu.....	80
Fig. 3-84	Comp. Menu.....	80
Fig. 3-85	Switch Count.....	81
Fig. 3-86	Conn. Time.....	81
Fig. 3-87	Learn Conn.....	82
Fig. 3-88	Learned Conn. Example-1.....	83
Fig. 3-89	Learned Conn. Example-1.....	83
Fig. 3-90	Learn Steps.....	84
Fig. 3-91	Learn Step.....	84
Fig. 3-92	Alarms Menu.....	85
Fig. 3-93	Phase1 Menu.....	85
Fig. 3-94	Step Menu.....	86
Fig. 3-95	Other Menu.....	87
Fig. 3-96	Analysis Menu.....	87
Fig. 3-97	Minimum Menu.....	88
Fig. 3-98	Hourly Menu.....	88
Fig. 3-99	Energy Menu.....	89
Figure 4-1	RS485 Wiring Diagram.....	92
Figure 4-2	RS485 PC Connection.....	92

## TABLES

Table 4-1	Message Format.....	93
Table 4-2	int (32 bit) data type.....	93
Table 4-3	Implemented functions for MODBUS RTU Protocol.....	93
Table 4-4	Readable Data(RAPIDUS 231R-E).....	95
Table 4-5	Readable Data(RAPIDUS 232R-E).....	109
Table 4-6	Setting Parameter (Available for RAPIDUS 231R-E).....	124
Table 4-7	String List (Available for RAPIDUS 231R-E).....	129
Table 4-8	Setting Parameter (Available for RAPIDUS 232R-E).....	129
Table 4-9	String List (Available for RAPIDUS 232R-E).....	135
Table 4-10	Archive (History) Record Table.....	136
Table 4-11	Clear Address Table.....	141





**RAPIDUS**

Power Factor  
Controller

**SECTION 1  
GENERAL  
INFORMATION**

## SECTION 1 GENERAL INFORMATION

### 1.1 Symbols

**Caution:**

This symbol indicates that there is cautionary information where it is used.

**Danger of Electric Shock:**

This symbol indicates that there is dangerous voltage or current.

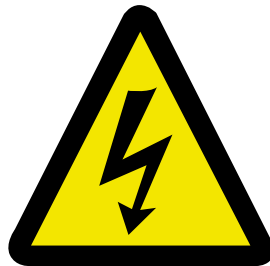

### 1.2 General Warnings

- Voltage measurement input connections:  
Overcurrent protection is required for voltage measurement connections V1, V2 and V3: 2 Arms gL fuses (IEC 269) or M type fuses (IEC 127) with rated voltage 300 VAC.
- Compensation relay connections:  
Overcurrent protection is required for compensation relay outputs. Fuses are recommended to be inserted at COM connections, namely COM1 (for 1..6 compensation relays) and COM2 (for 7..12 compensation relays). Technical details are as follows: 13 Arms gL fuses (IEC 269) or M type fuses (IEC 127) with rated voltage 300 VAC.
- Alarm relay connections:  
Overcurrent protection is required for alarm relay outputs: 3 Arms gL fuses (IEC 269) or M type fuses (IEC 127) with rated voltage 300 VAC.
- It is required to use a circuit breaker in order to easily disconnect RAPIDUS from mains. Circuit breaker should have the following specifications:
  - 4 poles (one pole for each phase and the fourth pole for the neutral line),
  - 300 VAC or above rated voltage
  - 1 A or above rated current
- "Do not use this product for any other purpose than it is designed for."

- When mounted on the wall of the panel enclosure, front side of RAPIDUS will be facing the operator. The remaining of RAPIDUS will be inside an enclosure. This panel enclosure should be a fire enclosure.
- Ensure that energy supply is cut off in the panel or in all relevant systems before attempting to connect the device to mains.
- Installation and connections shall be performed by qualified persons with respect to the instructions on the user's manual.
- Device shall only be activated after all connections are made.
- We advise you to connect a 2 A fuse between the voltage inputs of the device and the mains and supply input and mains.
- We advise you to connect a 1 mm<sup>2</sup> (AWG17) cable to supply input and measure inputs; and to connect a 2 mm<sup>2</sup> (AWG14Cu) cable to the current inputs.
- Do not remove RAPIDUS current transformer connections without short circuiting the K-L ends of the current transformer to somewhere else or connecting a load adequately low impedance to the K-L ends. Otherwise, dangerous high voltages may occur on the secondary ends of the current transformer. The same applies to starting of the device.
- Device shall be placed away from damped, wet, vibrating and dusty environments.
- Use a dry cloth to clean the device or remove the dust on it. Do not use alcohol, thinner or an abrasive agent.
- Do not open the inside of the device. There are no user-maintainable components inside.



### 1.3 Receipt Control and Contents of the Delivery

When the RAPIDUS is delivered to you, check that:

- the packing of RAPIDUS is in good condition
- the product is not damaged during transport
- name of the product and order number is correct.

RAPIDUS Order No:	Short code	Description
606005	RAPIDUS 231R-E	Rapidus 3 phase 12 relays
606007	RAPIDUS 232R-E	Rapidus 3 phase 24 relays

Contents of the RAPIDUS packing is listed below.

- 1 RAPIDUS
- 1 CD-ROM (User's Manual)
- 4 panel tightening tools
- 1 pc of 4-pin female terminal for alarm outputs (NO, C/out2, C/out1, NO)
- 1 pc of 6-pin female terminal for current inputs (I1, k1, I2, k2, I3, k3)
- 1 pc of 4-pin female terminal for voltage input (V1, V2, V3, N)
- 2 pcs of 7-pin female terminal for step outputs (Com1, Com2, K1...K12)
- 1 pc of RS485 3-pin female terminal (D+, GND, D-)
- 1 pc of 2-pin female terminal for generator input (GenA, GenB)

**NOTE:** 4 pcs of 7-pin female terminal for step outputs (Com1, Com2, Com3, Com4, K1...K24) for RAPIDUS 232R-E optional model.

## 1.4 RAPIDUS Reactive Power Control Relay

RAPIDUS is a multi-function reactive power control relay. It measures active, reactive and total powers of the system that it is connected. As a result of these measurements, it activates capacitor and shunt reactors in the compensation panel. Thus, it compensates the system reactive power bidirectionally.

RAPIDUS counters record "imported active", "exported active", "inductive reactive" and "capacitive reactive" energy values.

All user actions can be performed easily using the 160x240 graphic LCD display and 6 keys on the front panel.

RAPIDUS has an isolated RS485 port.

It also has 2 alarm relay outputs.

RAPIDUS measures/calculates

- Current, voltage and frequency
- Active, reactive and apparent power
- Current and voltage harmonics up to 51st harmonics
- THDV, THDI
- Power factor,  $\cos\phi$

values for each phase.

RAPIDUS has features such as:

- Learning connection methods
- Learning step powers and types
- Recording switching numbers and duty ratios for each step
- Compensation possibility with 6 different programs
- Determination of whether the activated step is faulty and dynamic step monitoring
- For active, reactive (inductive and capacitive) energy, values of index, hourly, previous hour, previous day, monthly and previous month
- Compensation in 12 steps
- Current and voltage harmonics measurement up to 51st harmonics
- Testing possibility for relays and steps
- Automatic calculation of C/k ratio

Also, RAPIDUS has the following features:

- Setting an alarm for various measurement parameters
- Provision of counter monitoring by assigning initial counter values
- Prevention of unauthorized usage with 4 digit password input
- Battery supported real time timer and memories

## 1.5 RAPIDUS Front Panel

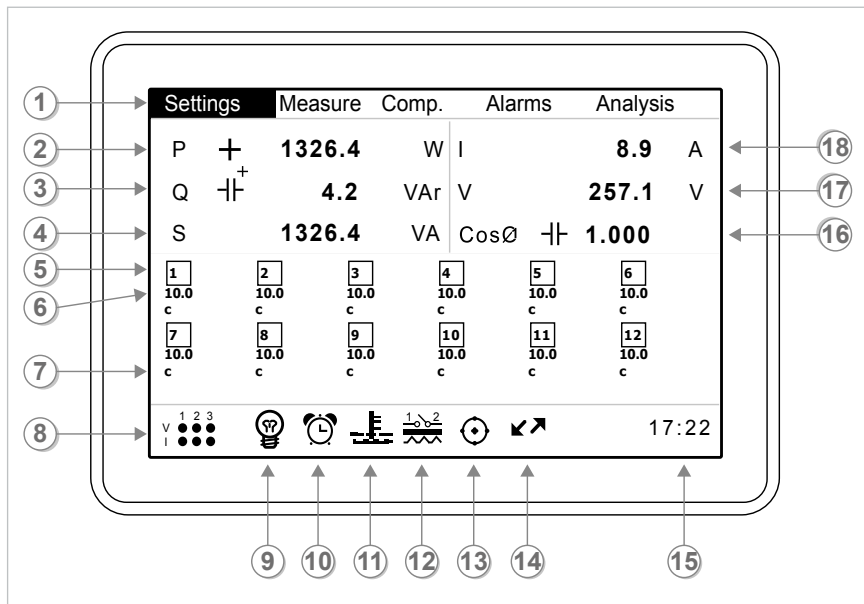

Fig. 1-1 RAPIDUS 231R-E

- 1 Menu
- 2 Total Active Power
- 3 Total Reactive Power
- 4 Total Apparent Power
- 5 Number of steps
- 6 Step power
- 7 Step type
- 8 Presence/absence of currents and voltages
- 9 Selected compensation mode
- 💡 => Rapidus mode (Smart mode)
- 📈 => Asc. sequential mode
- 📉 => Des. sequential mode
- 📊 => Lineer mode
- 🔄 => Circular mode
- 👉 => Manual mode
- ⚠️ => Caution Symbol (It is displayed when learning connections are failed)
- 🕒 => Hourglass (It is displayed when connections or step powers are being learned)
- 10 Alarm status symbol (displayed when alarm occurred in system)
- 11 Temperature alarm status symbol (displayed when an alarm occurred in the system)
- 12 Alarm relay symbol (This symbol is displayed if 1st and/or 2nd alarm relay is assigned to an alarm and an alarm is present in the system. "1" indicates 1st alarm relay, and "2" indicates 2nd alarm relay on the symbol)
- 13 Indicates that DCM is active
- 14 RS485 communication symbol
- 15 System clock
- 16 System CosØ value
- 17 Average VLL(line-line) voltages
- 18 Total Current of Three Phases

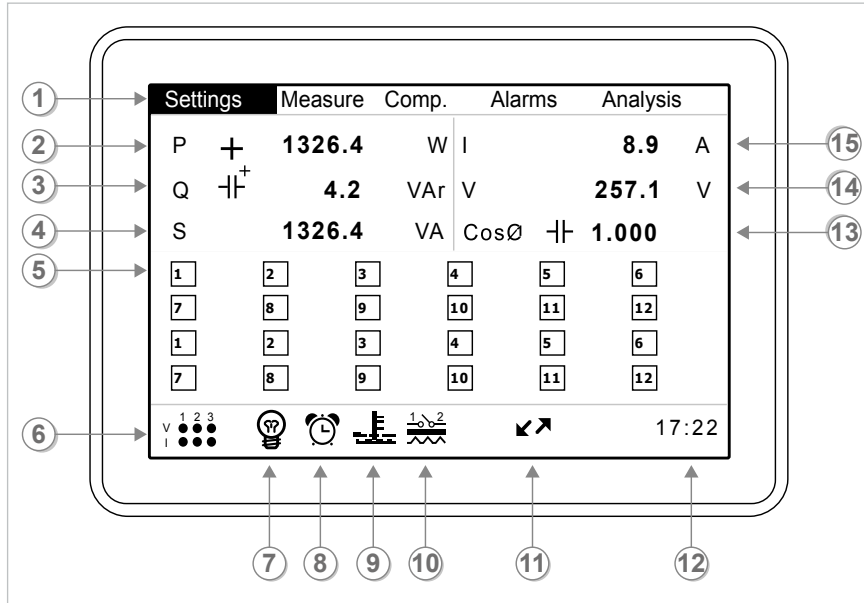

Fig. 1-2 RAPIDUS 232R-E

- 1 Menu
- 2 Total Active Power
- 3 Total Reactive Power
- 4 Total Apparent Power
- 5 Number of steps
- 6 Presence/absence of currents and voltages
- 7 Selected compensation mode
  - ⚡ => Rapidus mode (Smart mode)
  - ↑ => Asc. sequential mode
  - ↓ => Des. sequential mode
  - || => Lineer mode
  - 🔄 => Circular mode
  - 👉 => Manual mode
  - ⚠ => Caution Symbol (It is displayed when learning connections are failed)
  - 🕒 => Hourglass (It is displayed when connections or step powers are being learned)
- 8 Alarm status symbol (displayed when alarm occurred in system)
- 9 Temperature alarm status symbol (displayed when an alarm occurred in the system)
- 10 Alarm relay symbol (This symbol is displayed if 1st and/or 2nd alarm relay is assigned to an alarm and an alarm is present in the system. "1" indicates 1st alarm relay, and "2" indicates 2nd alarm relay on the symbol)
- 11 RS485 communication symbol
- 12 System clock
- 13 System CosØ value
- 14 Average VLL(line-line) voltages
- 15 Total Current of Three Phases

If operator press down key, below screen is shown.

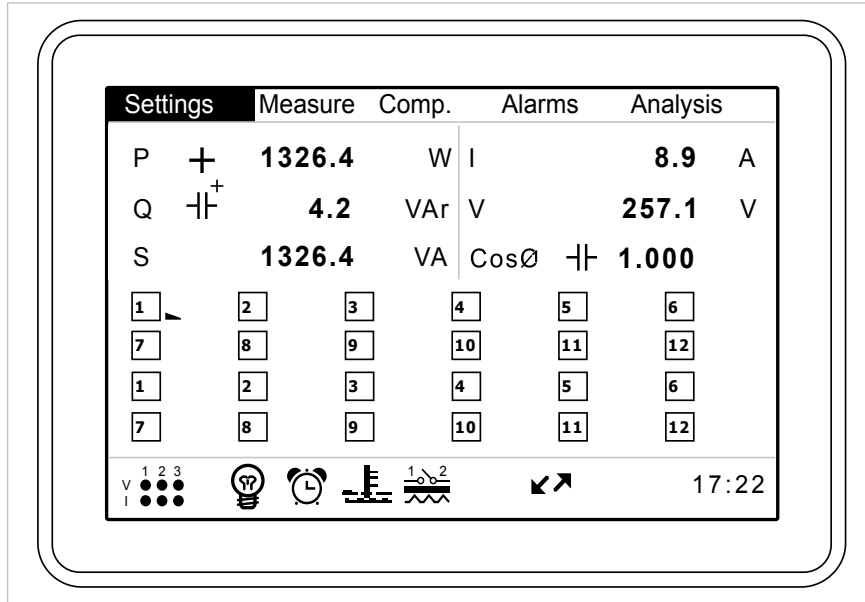

Fig. 1-3 RAPIDUS with 24 RELAYS

Operator can scroll inside steps by pressing right and left keys. When OK key is pressed below screen is shown.

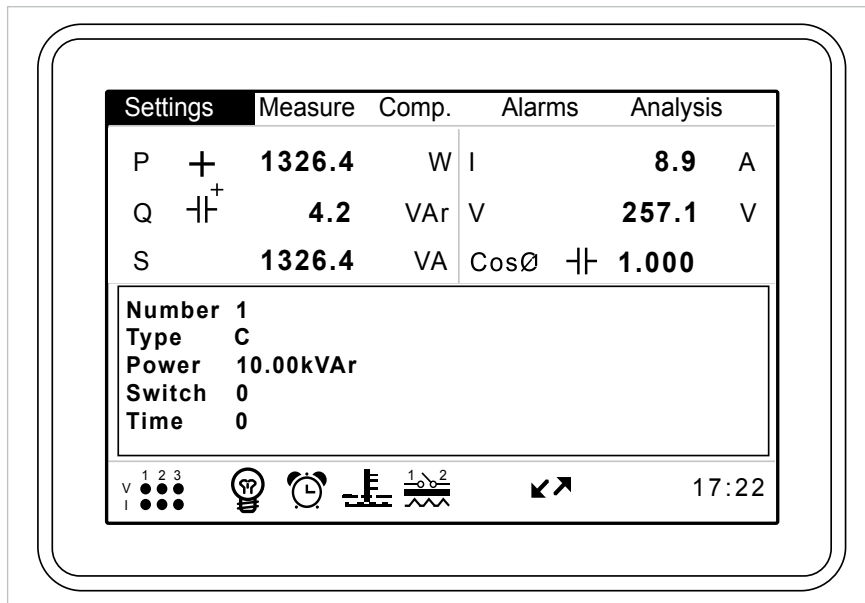

Fig. 1-4 Step Information Screen for RAPIDUS 232R-E





## 1.6 Four-Quadrant Representation

The angle( $\emptyset$ ) between voltage and current provides us information about the direction of energy flow. A positive sign for active/reactive power indicates that active/reactive power is consumed.

And also a negative sign for active/reactive power indicates that active/reactive power is generated.

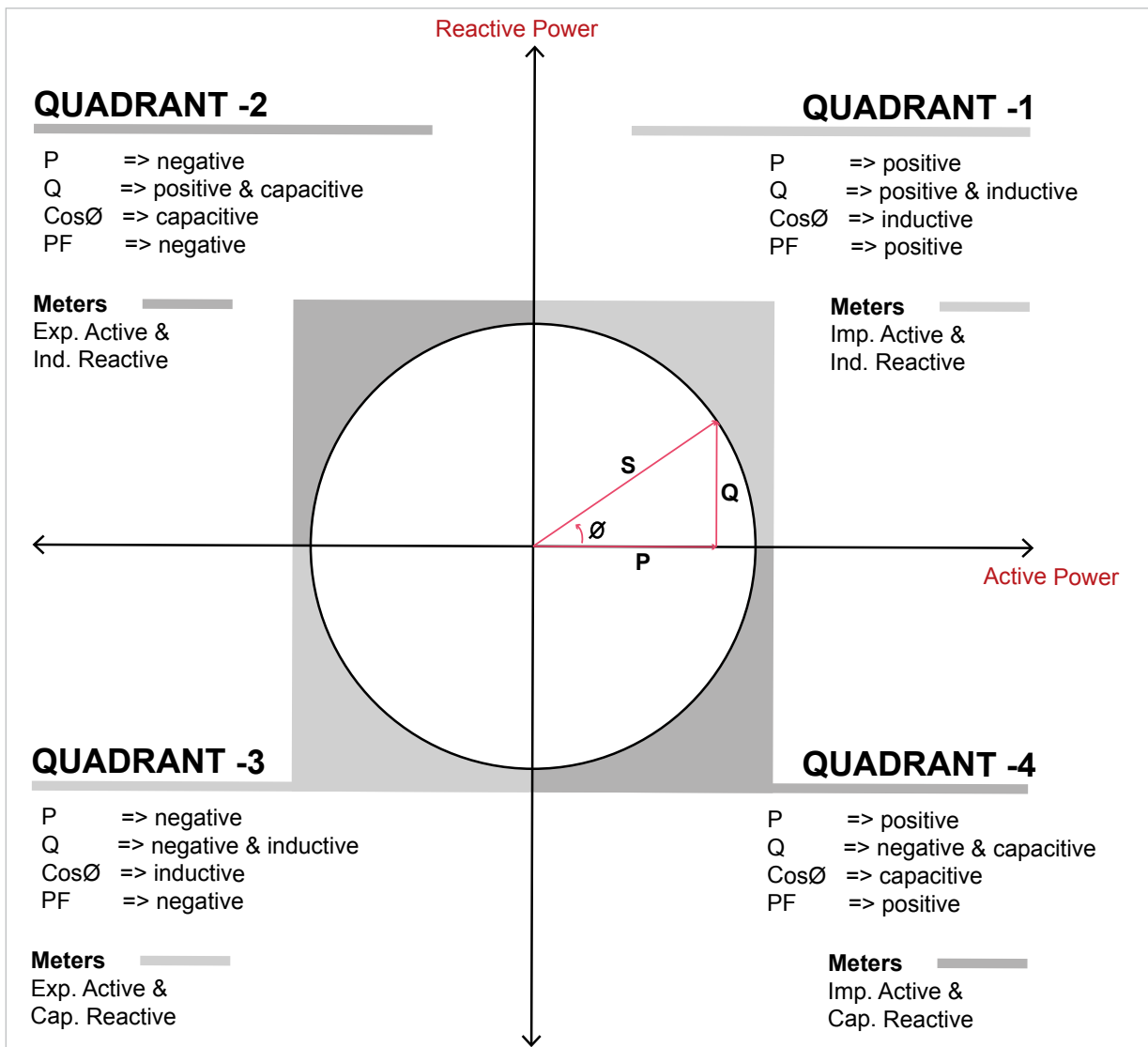

Fig. 1-5 Four-Quadrant Representation

**NOTE:** If the signs of active and reactive power are examined, it can be defined the quadrant that Rapidus measures.

e.g.

- P= +10kWh, Q= +5kVAr => Quadrant-1
- P= -10kWh, Q= +5kVAr => Quadrant-2
- P= -10kWh, Q= -5kVAr => Quadrant-3
- P= +10kWh, Q= -5kVAr => Quadrant-4



**RAPIDUS**

Power Factor  
Controller

**SECTION 2**  
**INSTALLATION**

## SECTION 2 INSTALLATION

This section contains information on the installation, cable connections and connection methods of RAPIDUS.

### 2.1 Preparation for Installation

RAPIDUS that you have purchased may not include all hardware options specified in the installation manual. This is not issue for the electrical installation.



Installation and connections of RAPIDUS shall be performed by qualified persons with respect to the instructions on the user's manual.



Do not operate the device before making the connections correctly.

### 2.2 Placing on the panel

RAPIDUS is placed vertically on the empty compartment on the panel.

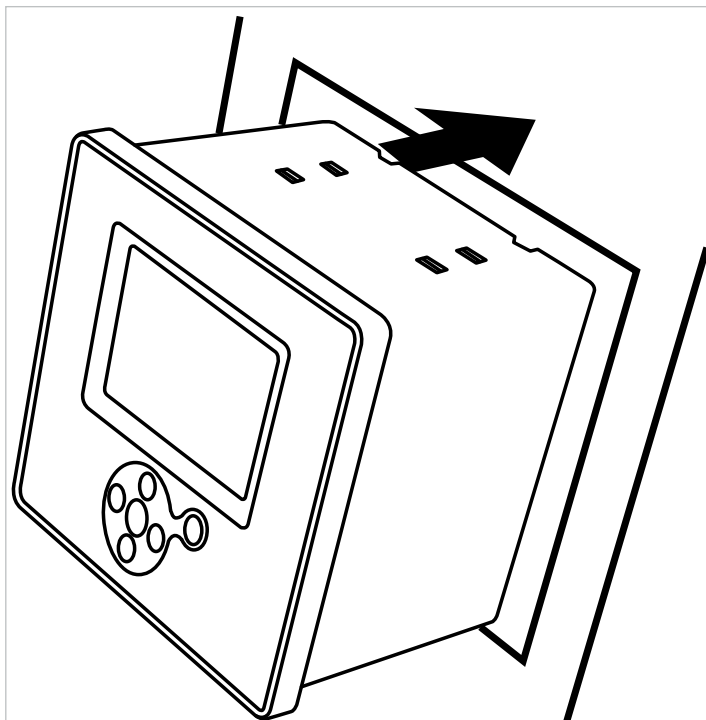

Fig. 2-1 Placing RAPIDUS on the Panel

After placing RAPIDUS on the panel tightening tool is installed and then secured by tightening its screw.

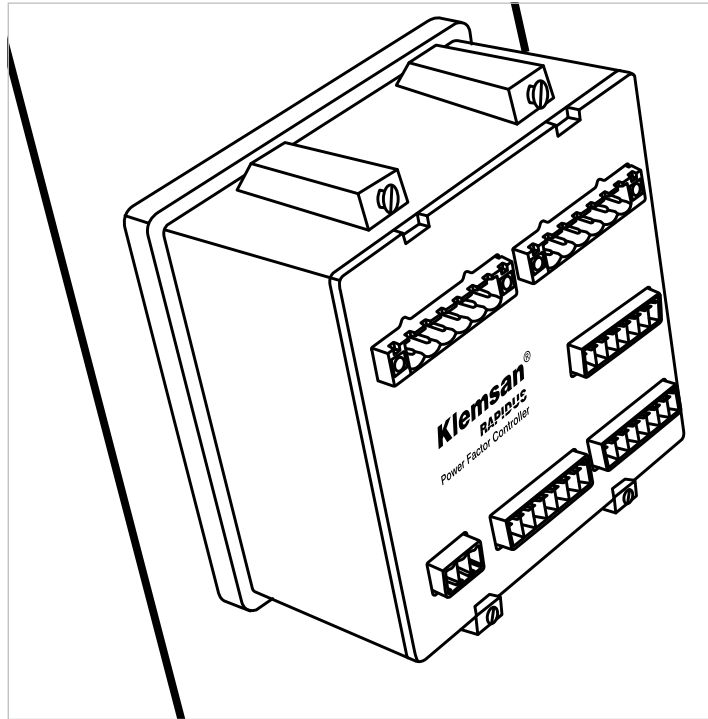

Fig. 2-2 Securing RAPIDUS

RAPIDUS has female terminals with 2.5mm<sup>2</sup> and 1.5mm<sup>2</sup> screws. Female terminal is removed on its housing on RAPIDUS (removed from the fixed male terminal). Screws on the female terminal are loosened.

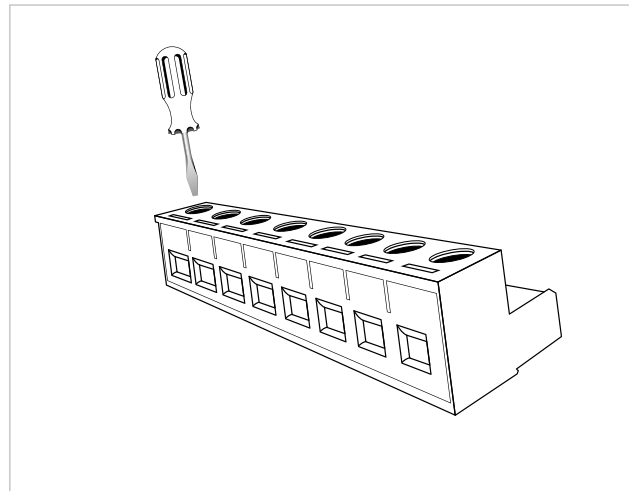

Fig. 2-3 Loosening of the Terminal Screws



Make sure that the power is cut off before connecting voltage and current ends to RAPIDUS.



Do not remove RAPIDUS current transformer connections without short circuiting the K-L ends of the current transformer to somewhere else. Otherwise, dangerous high voltages may occur on the secondary ends of the current transformer. The same applies to starting of the device.

Cable is placed in the relevant connection hole.

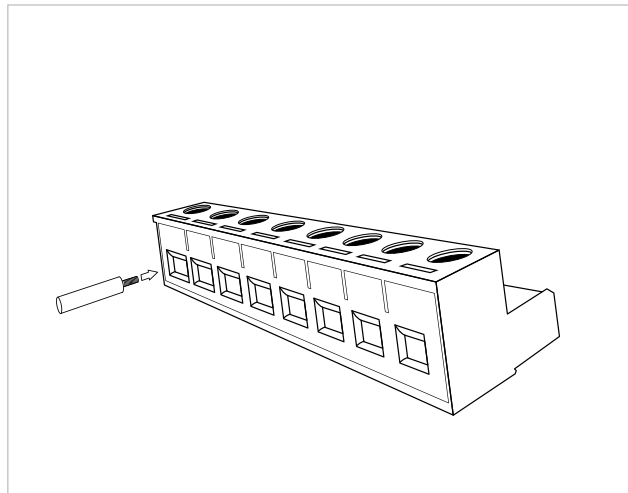

Fig. 2-4 Inserting Cable into the Terminal Block

After the cable is placed, the screws are tightened and the cable is fixed.

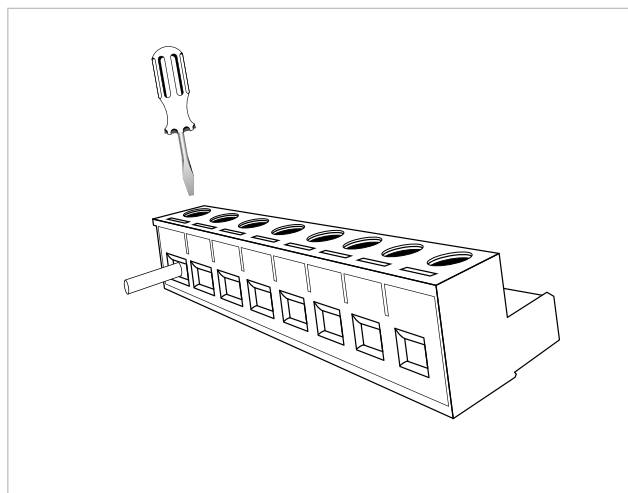

Fig. 2-5 Fixing the Cable to the Terminal Block

Terminal is placed on its housing on RAPIDUS.



Consider this warning if RAPIDUS is used with current transformers. Correct operating threshold values of transformers vary as per the type and size of the current transformers used. Please check that the measured current value is higher than the current threshold specified in the user's manual of current transformer."

### 2.3 Wiring Diagrams

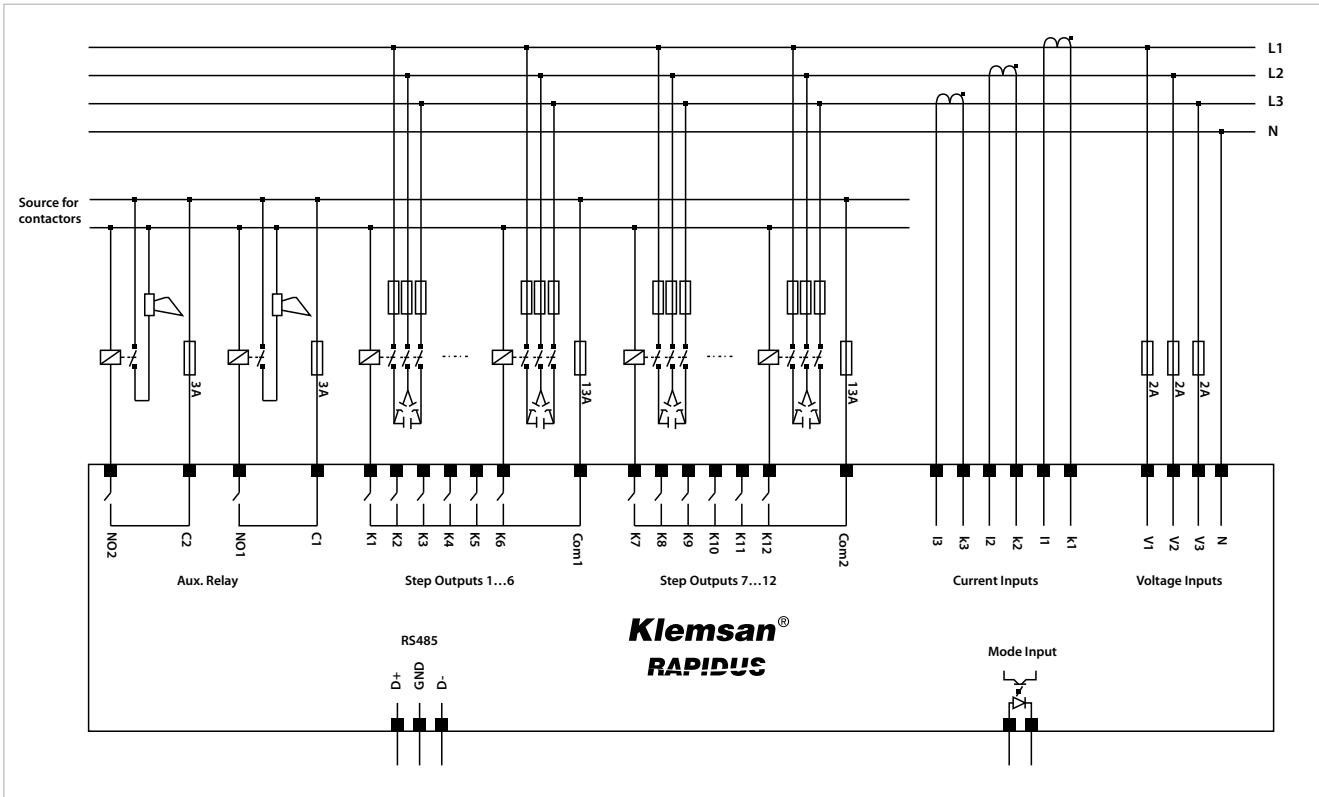

Fig. 2-6 RAPIDUS Connection Diagram (12 Steps)

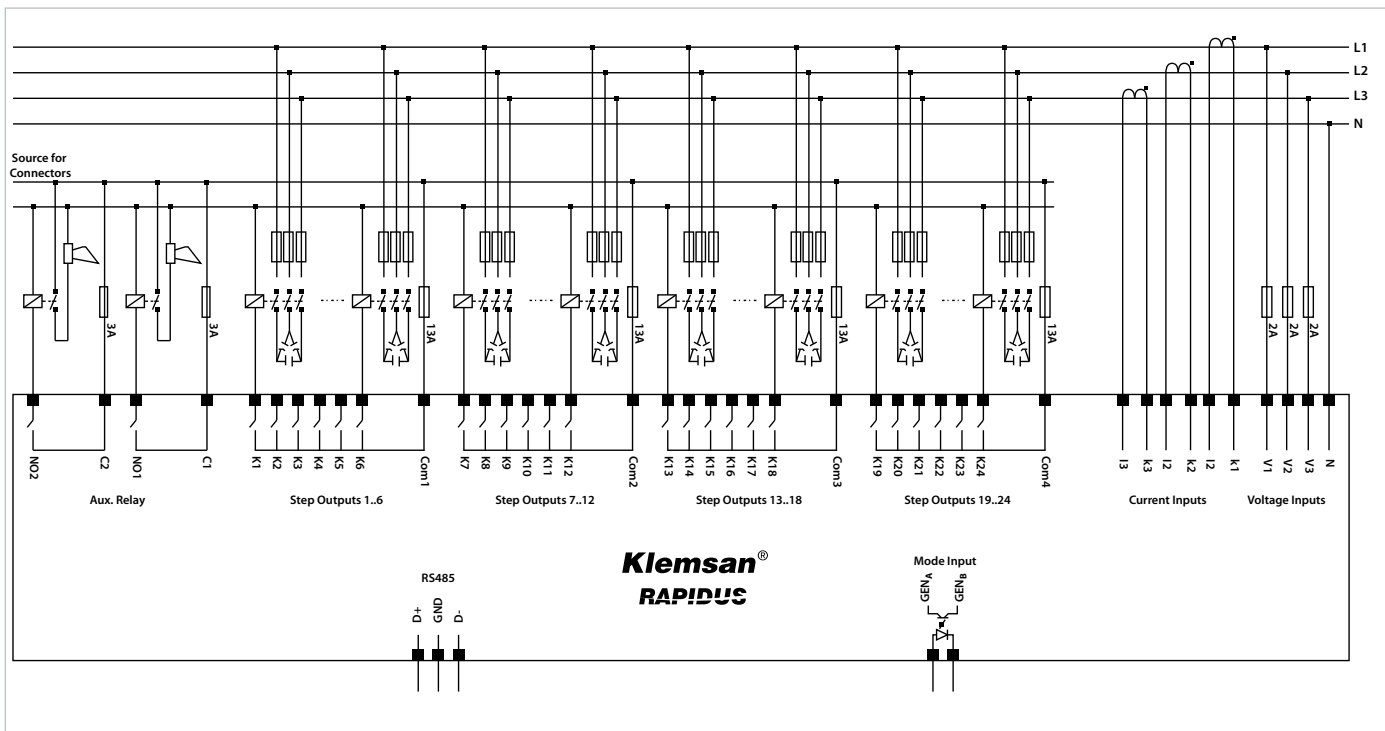

Fig. 2-7 Rapidus Connection Diagram (24 Steps)

## 2.4 Dimensions

Dimensions are in millimeters.

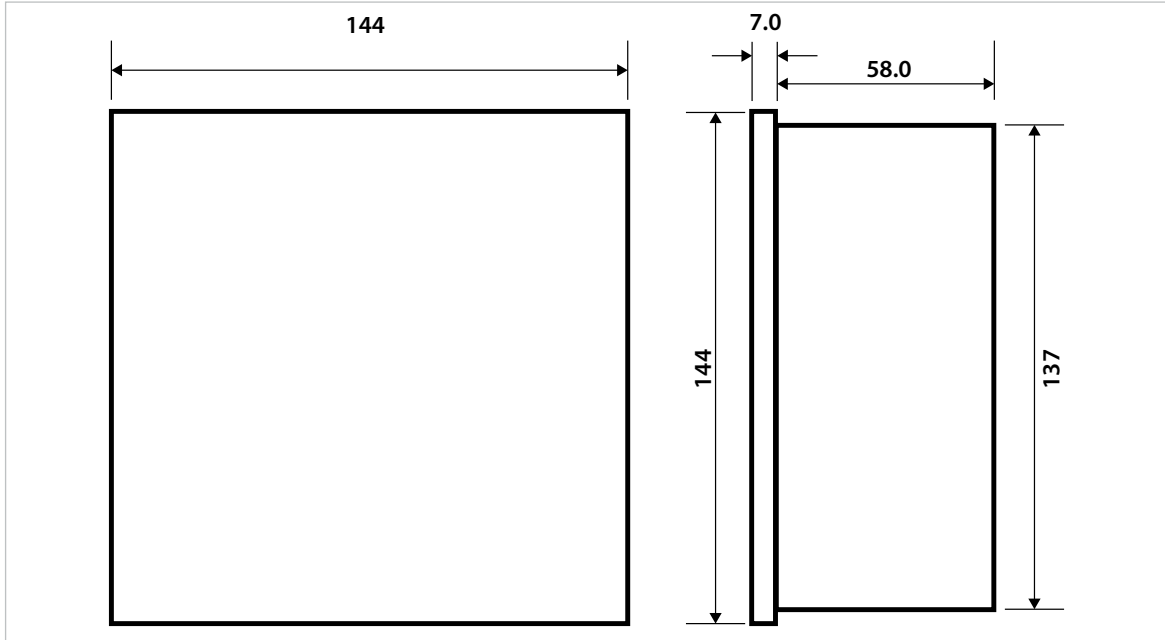

Fig. 2-8 Dimensions



**RAPIDUS**

Power Factor  
Controller

**SECTION 3  
MENUS**



## SECTION 3 MENUS

### 3.1 “First Power-on” Settings

The following page is displayed when RAPIDUS is energized for the “first time” after it is released from the factory



Fig. 3-1 First Operation Settings

#### 3.1.1 Dil / Lang. / Язык Setting

“Türkçe”, “English” and “Русский” language options are displayed when you press OK while this tab is selected. User shall select the desired option with up and down arrows and press “OK”. If the language is selected as English, the language settings for all other tabs shall also be English.

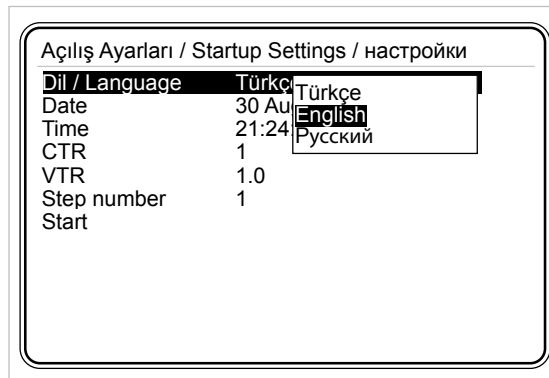

Fig. 3-2 Dil / Lang./ Язык Setting

### 3.1.2 Date

Date setting of RAPIDUS is performed here. Press OK when this option selected. Highlight day, month or year digits with the right and left arrow keys. Date setting is performed with up and down keys. Date setting is completed by pressing OK.



Fig. 3-3 Date Setting

**Example:** To select "August 30th, 2013":

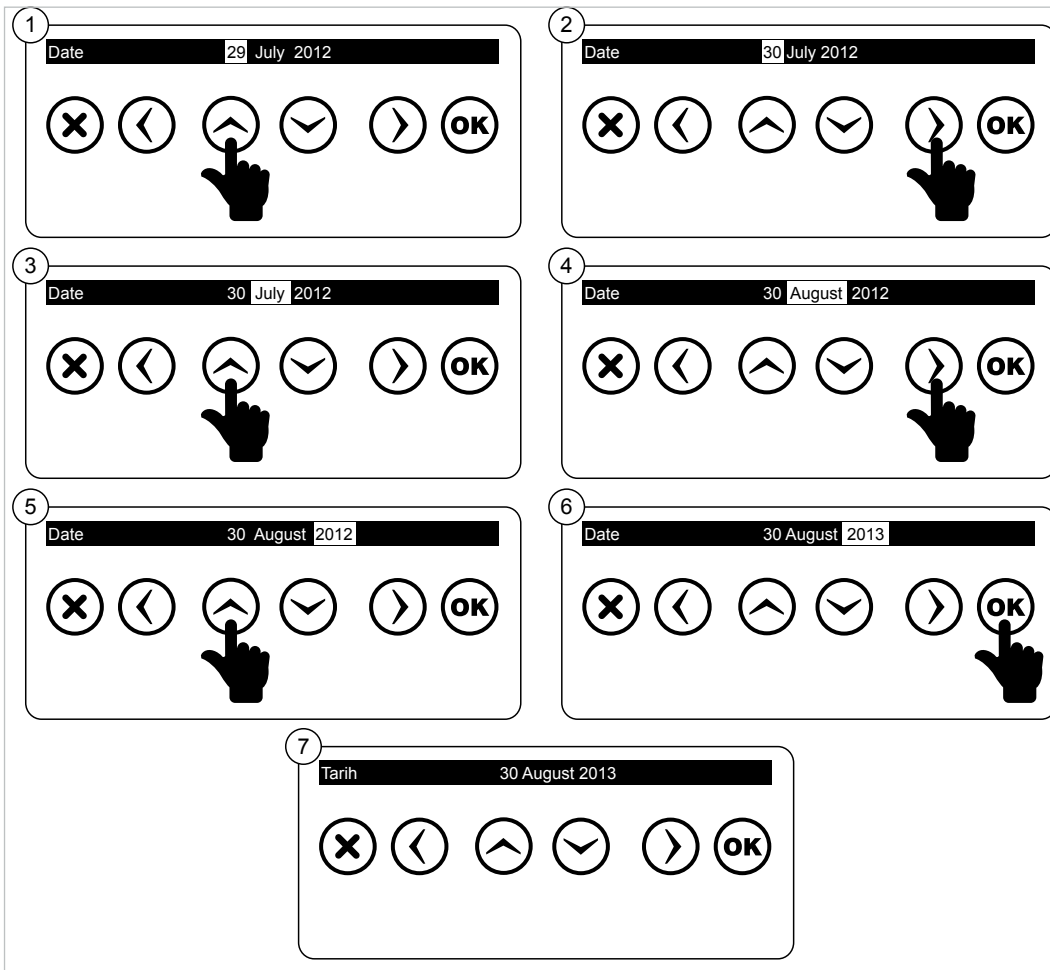

Fig. 3-4 Date Setting Example

### 3.1.3 Time

Time setting of RAPIDUS is performed here. It is set as described on [3.1.2 Date](#) menu.

### 3.1.4 Current Transformer Ratio (CTR)

This is the settings tab for entering the current transformer ratio. Current transformer ratio may be selected between 1 and 5000. RAPIDUS Virtual Keyboard shall be displayed when you press OK when this option selected.

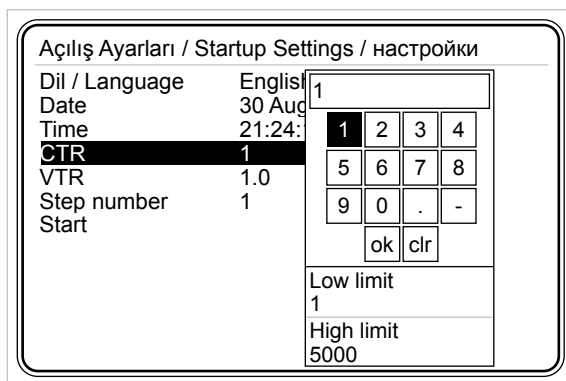

Fig. 3-5 Current Transformer Ratio

Use arrow keys to navigate between the digits and OK key to enter the selected digit as a value. If you enter an incorrect number, select **clr** box and press OK. Thus, the incorrect number entered shall be deleted.



Current transformer ratio shall be entered correctly to ensure that RAPIDUS performs a correct compensation.

Example:

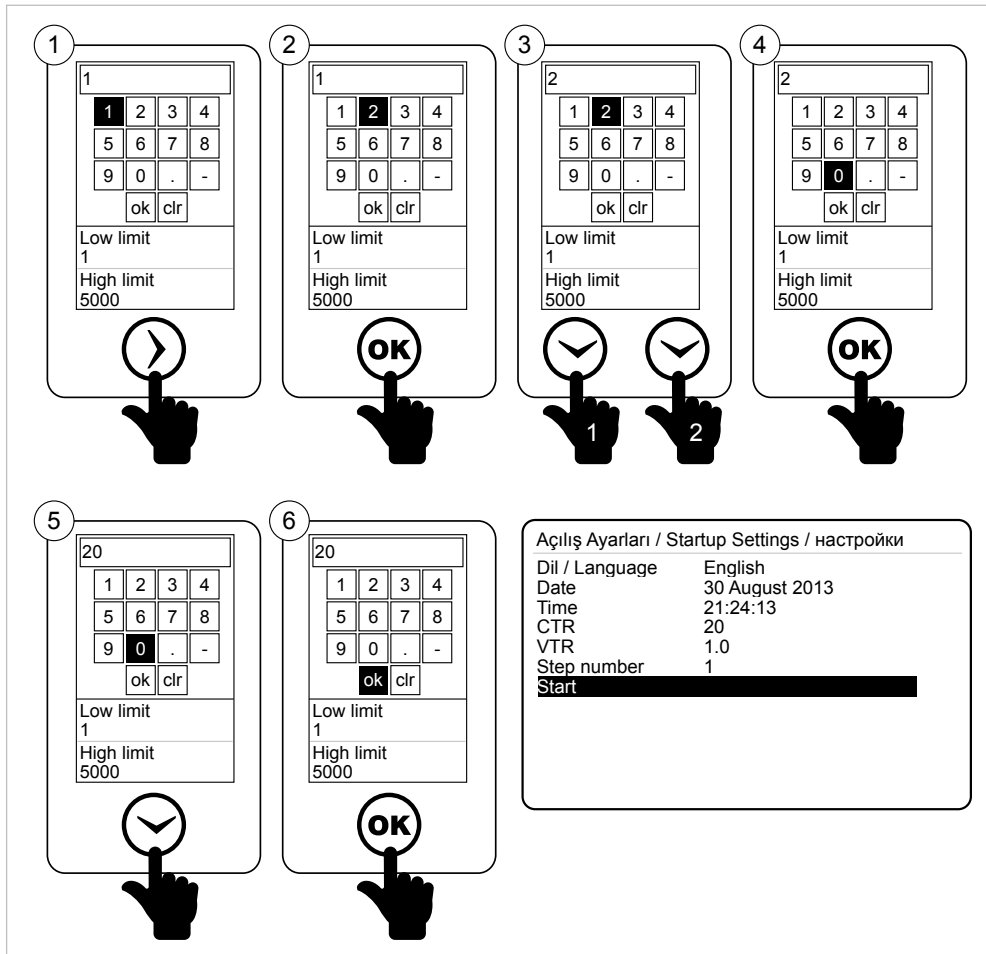

Fig. 3-6 Entering a Value in Virtual Keyboard

### 3.1.5 Voltage Transformer Ratio (VTR)

This is the settings tab for entering the voltage transformer ratio. Voltage transformer ratio may be selected between 1 and 5000. (For the usage of RAPIDUS Virtual Keyboard, Refer to 3.1.4 Ex.). If you will enter a number with a decimal place for voltage transformer ratio, select the  box on the Virtual Keyboard with arrow keys and press OK.

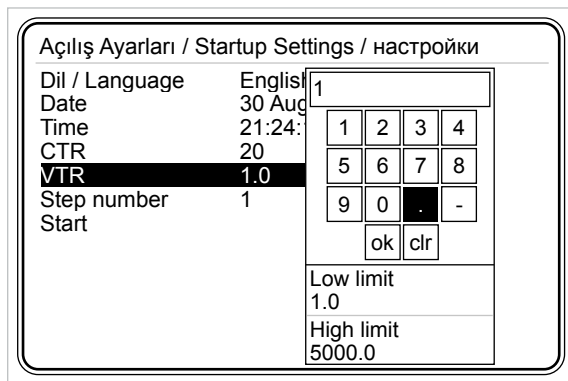

Fig. 3-7 Voltage Transformer Ratio



Voltage transformer ratio shall be entered correctly to ensure that RAPIDUS performs a correct compensation.

### 3.1.6 Step number

You shall enter the 3-phase capacitor step number required for learning the connections from this menu

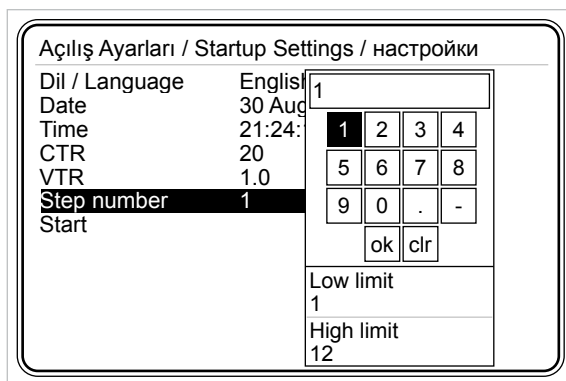

Fig. 3-8 Step Structure

### 3.1.7 Restart

RAPIDUS shall be restarted when you press OK when the Restart tab is highlighted.

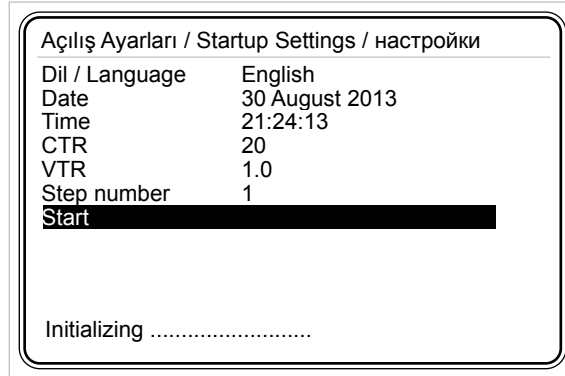

Fig. 3-9 Restart



RAPIDUS startup settings page is displayed when the RAPIDUS is powered up for the first time. After RAPIDUS is restarted, all settings (including startup settings) may be changed from the Settings menu.

### 3.2 Startup Screen

If "Settings=>Setup=>Learn=>Learn conn.=> learn at start" function is adjusted as "On", following screen page shall be displayed after RAPIDUS is started. Device shall learn the connections first, and then the step powers respectively when it is started.

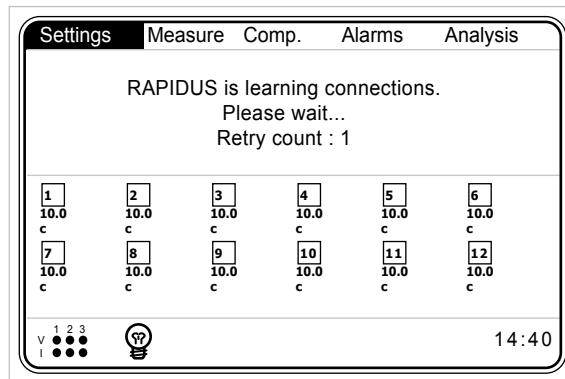

Fig. 3-10 Startup Screen when the Connections Are Being Learned

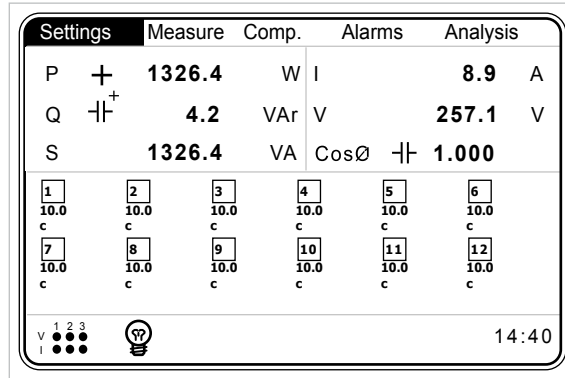

Fig. 3-11 Startup Screen after the Connections Are Learned

Multi selection menus are displayed on the upper part of the screen.

User may navigate on the menus on the upper side of the screen using left and right arrow keys, and access the contents of the menus by pressing OK.

### 3.2.1 Settings

RAPIDUS settings are made from this menu. If you press OK when the settings tab is highlighted, sub-menus shall be displayed as shown in Fig. 3-12. Sub-menus below are available under the settings tab.

- Quick setup
- Setup
- Date/Time
- System info
- Password
- Restart
- Default Settings

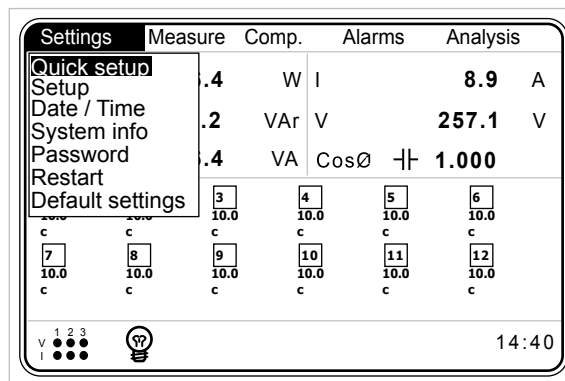

Fig. 3-12 Settings Menu



### 3.2.1.1 Quick setup Menu

Sub-menus below are available under the quick setup tab:

- Dil / Lang. / Язык
- Date
- Time
- CTR
- VTR
- Step number

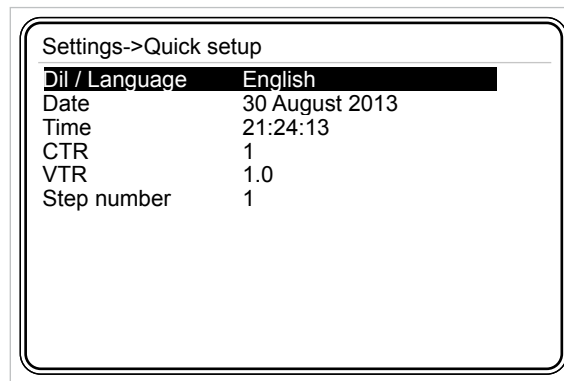

Fig. 3-13 Quick Setup Menu

#### 3.2.1.1.1 Language Setting

Language is selected in this tab ([See 3.1.1](#)).

#### 3.2.1.1.2 Date Menu

Date setting is performed here ([See 3.1.2](#)).

#### 3.2.1.1.3 Time Menu

Time setting is performed here ([See 3.1.3](#)).

#### 3.2.1.1.4 CTR

Current transformer ratio is entered here ([See 3.1.4](#)).

#### 3.2.1.1.5 VTR

Voltage transformer ratio is entered here ([See 3.1.5](#)).

#### 3.2.1.1.6 Step number

RAPIDUS activates a 3-phase capacitor when it learns the connections. You shall enter the 3-phase capacitor number to be used for learning the connections in this menu.



In order to store the new settings in the nonvolatile memory, you shall return back to the "Startup Screen" from the tab where the changes are made using X key. Press OK when "Settings changed. Save?" message is displayed on the Screen. Thus, the changes are saved and stored in the nonvolatile memory. The changes shall not be saved and stored in the nonvolatile memory if X key is pressed.

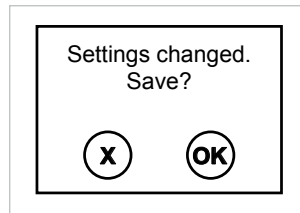

Fig. 3-14 RAPIDUS Prompt for saving



Changes shall be saved on the nonvolatile memory if you press OK when "Settings changed. Save?" message is displayed on the Screen. The changes shall not be saved and stored in the nonvolatile memory if X key is pressed.

### 3.2.1.2 Setup Menu

Sub-menus below are available under the setup tab:

- Network
- Step
- Compensation
- Learning
- Aux. input
- Device
- Energy
- Communication
- Alarm
- Clear

User may navigate inside the menu using up and down arrow keys, and access the contents of the menus (sub-menus under the setup menu) by pressing OK.

### 3.2.1.2.1 Network Menu

This menu is used for performing the network settings.

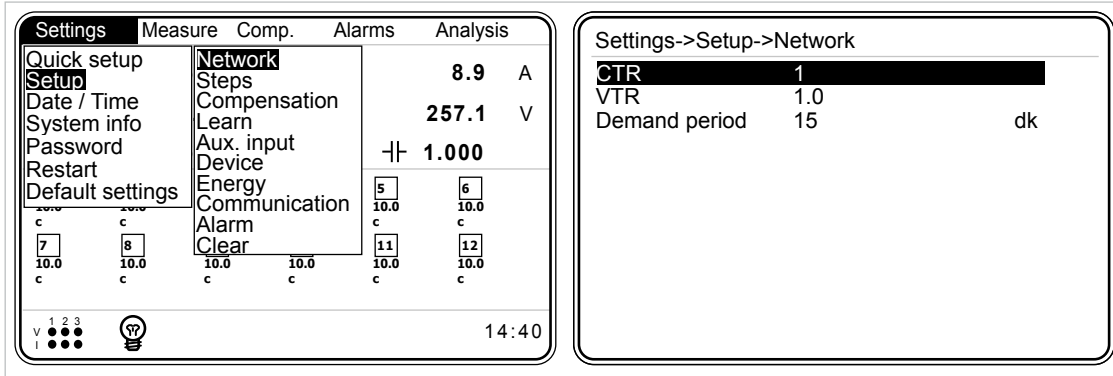

Fig. 3-15 Network Menu

#### 3.2.1.2.1.1 CTR Setting

This is the settings tab for entering the current transformer ratio. Current transformer ratio may be selected between 1 and 5000. (For the usage of RAPIDUS Virtual Keyboard, Refer to 3.1.4 Ex.)

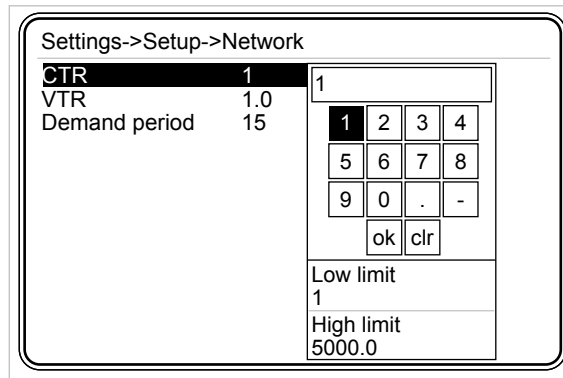

Fig. 3-16 Current Transformer Ratio Setting



Current transformer ratio shall be entered correctly to ensure that RAPIDUS performs a correct measurement.

### 3.2.1.2.1.2 VTR Setting

This is the settings tab for entering the voltage transformer ratio. Voltage transformer ratio may be selected between 1.0 and 5000.0. (For the usage of RAPIDUS Virtual Keyboard, Refer to 3.1.4 Ex.) If you will enter a number with a decimal place for voltage transformer ratio, select the  box on the Virtual Keyboard with arrow keys and press OK.



Voltage transformer ratio shall be entered correctly to ensure that RAPIDUS performs a correct measurement.

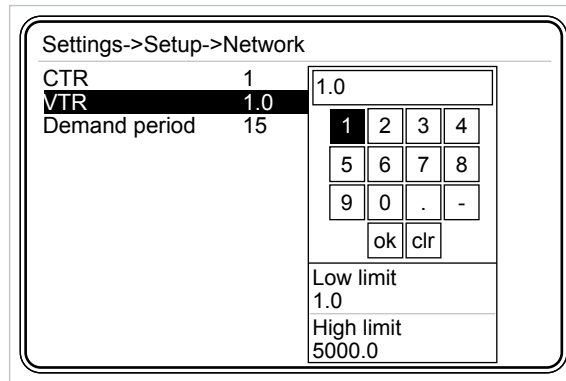

Fig. 3-17 Voltage Transformer Ratio Setting

### 3.2.1.2.1.3 Demand period setting

This is the settings tab for entering the demand period. Demand period may be selected between 1 and 60 minutes. (For the usage of RAPIDUS Virtual Keyboard, Refer to 3.1.4 Ex.)

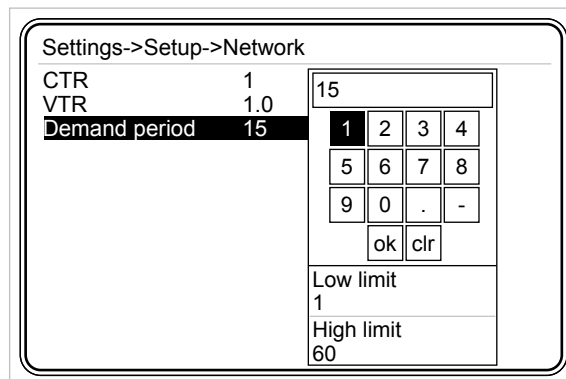
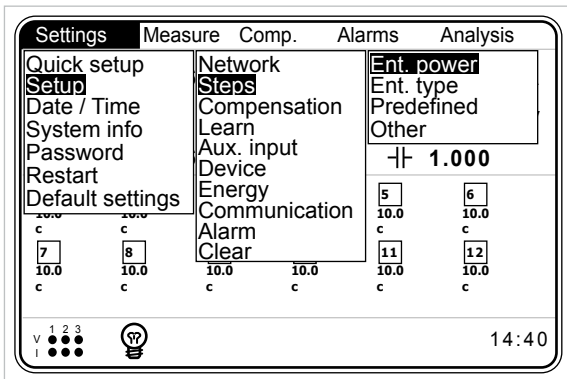

Fig. 3-18 Demand Period Setting

### 3.2.1.2.2 Step Menu

This menu includes the sub-menus below:

- Ent. power
- Ent. type
- Predefined
- Other



**NOTE:** There are two Ent. Power sub menus for RAPIDUS 232R-E. Operator can assign 1<sup>st</sup>, 2<sup>nd</sup>, ... and 12<sup>th</sup> step powers in "Ent. Power 1" Submenu. Operator can assign 13<sup>th</sup>, 14<sup>th</sup>, ...and 24<sup>th</sup> step powers in "Ent. Power 1" Submenu.

Fig. 3-19 Step Menu

### 3.2.1.2.2.1 Ent. Power Menu

Step powers learned by RAPIDUS are indicated in this menu. Also, user may enter/change all step powers manually using this menu.

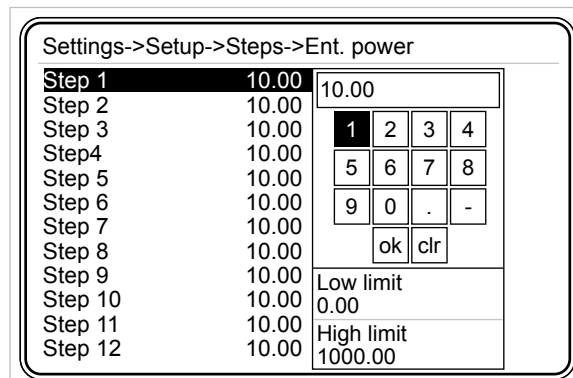

Fig. 3-20 Ent. Power Menu

### 3.2.1.2.2.2 Ent. Type Menu

Step types learned by RAPIDUS are indicated or user may set the step powers in this menu.

- "C" is for 3-phase capacitor,
- "C1" is for single-phase capacitor connected to R phase,
- "C2" is for single-phase capacitor connected to S phase,

- "C3" is for single-phase capacitor connected to T phase,
- "L" is for 3-phase shunt reactor,
- "L1" is for single-phase shunt reactor connected to R phase,
- "L2" is for single-phase shunt reactor connected to S phase,
- "L3" is for single-phase shunt reactor connected to T phase,
- "C1-2" is for two-phase capacitor connected to R and S "phases (RAPIDUS 232R-E doesn't support)"
- "C2-3" is for two-phase capacitor connected to S and T "phases (RAPIDUS 232R-E doesn't support)"
- "C3-1" is for two-phase capacitor connected to R and T "phases (RAPIDUS 232R-E doesn't support)",



You shall check whether RAPIDUS has learned step types correctly from this menu. If RAPIDUS has not learned step types correctly, perform one of the following.

- RAPIDUS is commanded to learn the steps again (See 3.2.3.6 Learn Steps Menu)
- Step types are corrected manually. (See Fig. 3-21)

Settings->Setup->Steps->Ent. type		
Step 1	C	C
Step 2	C	L
Step 3	C	C1
Step 4	C	C2
Step 5	C	C3
Step 6	C	L1
Step 7	C	L2
Step 8	C	L3
Step 9	C	C1-2
Step 10	C	C2-3
Step 11	C	C3-1
Step 12	C	L1-2

**NOTE:** There are two "Ent. Type" submenus for RAPIDUS 232R-E. Operator can assign 1<sup>st</sup>, 2<sup>nd</sup>, ... and 12<sup>th</sup> step powers in "Ent. Type 1" Submenu. Operator can assign 13<sup>th</sup>, 14<sup>th</sup>, ...and 24<sup>th</sup> step powers in "Ent. Type 2" Submenu.

Fig. 3-21 Ent. Type Menu

### 3.2.1.2.2.3 Predefined Menu

Step settings may be performed as per a predefined structure. Relevant settings are performed on the following three sub-menus specified below for predefined menu.

Settings->Setup->Steps->Predefined		
Structure	1 - 1 - 1 - 1	1 - 1 - 1 - 1
Power	10.00	1 - 1 - 2 - 2
Count	12	1 - 2 - 2 - 4
		1 - 2 - 3 - 3
		1 - 2 - 4 - 4
		1 - 1 - 2 - 4
		1 - 2 - 3 - 4
		1 - 2 - 4 - 8
		1 - 1 - 2 - 3

Fig. 3-22 Predefined Menu



### 3.2.1.2.2.3.1 Structure Menu

Following options are available on the step structure

- 1.1.1.1.1.1.....
- 1.1.2.2.2.2.....
- 1.2.2.4.4.4.....
- 1.2.3.3.3.3.....
- 1.2.4.4.4.4.....
- 1.1.2.4.4.4.....
- 1.2.3.4.4.4.....
- 1.2.4.8.8.8.....
- 1.1.2.3.3.3.....

### 3.2.1.2.2.3.2 Power Menu

Power of the first step is entered in kVAR. RAPIDUS calculates the step powers after the first step as per the selected template selected in the structure menu.

### 3.2.1.2.2.3.3 Number Menu

Number of steps in the template selected in structure is set in this menu.

#### **Example:**

Assume that 1.2.4.8 is selected as the structure, and 10 kVAR is entered as the power (RAPIDUS takes this value as the 1st step power), and 8 is entered as the number. Then, step powers shall be as follows:

- 1st step: 10 kVAR
- 2nd step: 20 kVAR
- 3rd step: 40 kVAR
- 4th step: 80 kVAR
- 5th step: 80 kVAR
- 6th step: 80 kVAR
- 7th step: 80 kVAR
- 8th step: 80 kVAR

### 3.2.1.2.2.4 Other Menu

Discharge time is entered here. RAPIDUS waits for the discharge time before reactivating a step that it has deactivated.

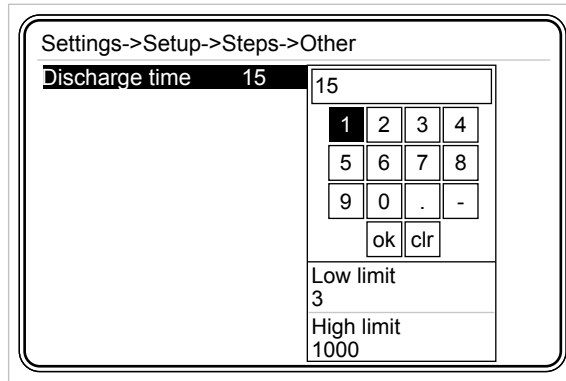

Fig. 3-23 Other Menu

### 3.2.1.2.3 Compensation Menu

Compensation menu is composed of the tabs shown in Fig. 3-24.

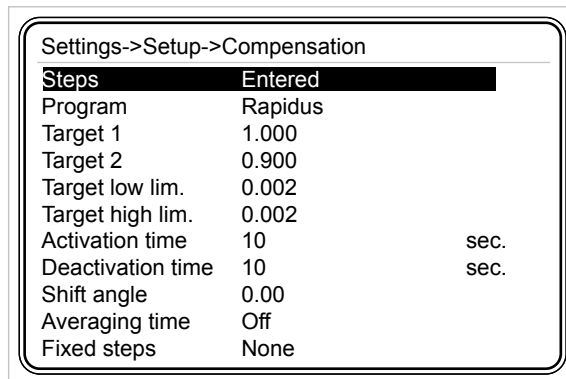

Fig. 3-24 Compensation Menu

#### 3.2.1.2.3.1 Steps Menu

RAPIDUS activates and deactivates steps when it performs reactive power compensation. Step types and power values are determined with 3 different methods.

**Entered:**

User has entered step values manually to RAPIDUS (See 3.2.1.2.2.1 Ent. Power Menu). RAPIDUS uses these values if “Entered” is selected.

**Predefined:**

User has entered the step power as described in predefined menu (See 3.2.1.2.2.3 Predefined). RAPIDUS uses these values if “Predefined” is selected.

### DCM (Dynamic Capacitor Monitoring):

RAPIDUS follows the step values dynamically. DCM algorithm runs on the background continuously.

When user selects “DCM” option on the “Steps” tab, RAPIDUS uses the step values that it dynamically monitors and updates for compensation.

*NOT: DCM(Dynamic Capacitor Monitoring) feature isn't available in for RAPIDUS 232R-E optional model.*

#### 3.2.1.2.3.2 Program Menu

RAPIDUS has compensate with 6 different programs.

Rapidus Asc. Sequential, Des. Sequential, Linear and Circular options are programs with their own algorithms.

In the manual option, operator may activate and deactivate any step; RAPIDUS does nothing more than allowing manual access to the operator in this program.

Following features are available in all compensation programs other than “Manual”:

- User may enter any type (capacitor or shunt reactor) and order of steps to RAPIDUS:
- RAPIDUS does not use (ignores) the steps that it has learned as “0” or that is entered by the user as “0”.
- When it has learned a single- or two-phase step, if at least one step is entered as single- or two-phase by the user, RAPIDUS automatically runs on the “Rapidus” compensation program.

Settings->Setup->Compensation		
Steps	Entered	Rapidus
Program	Rapidus	Asc. sequential Des. sequential Linear Circular Manual
Target 1	1.000	
Target 2	0.900	
Target low lim.	0.002	
Target high lim.	0.002	
Activation time	10	sec.
Deactivation time	10	sec.
Shift angle	0.00	
Averaging time	Off	
Fixed steps	None	

Fig. 3-25 Program Menu





### 3.2.1.2.3.2.1 Rapidus Program



“Rapidus” option is the only compensation program that allows single- or two-phase capacitors and/or single- or two-phase shunt reactor (other than “Manual”)

The compensation program selected in the default settings (factory settings) of RAPIDUS is the “Rapidus” option. It activates the step combination closest to the measured demand.

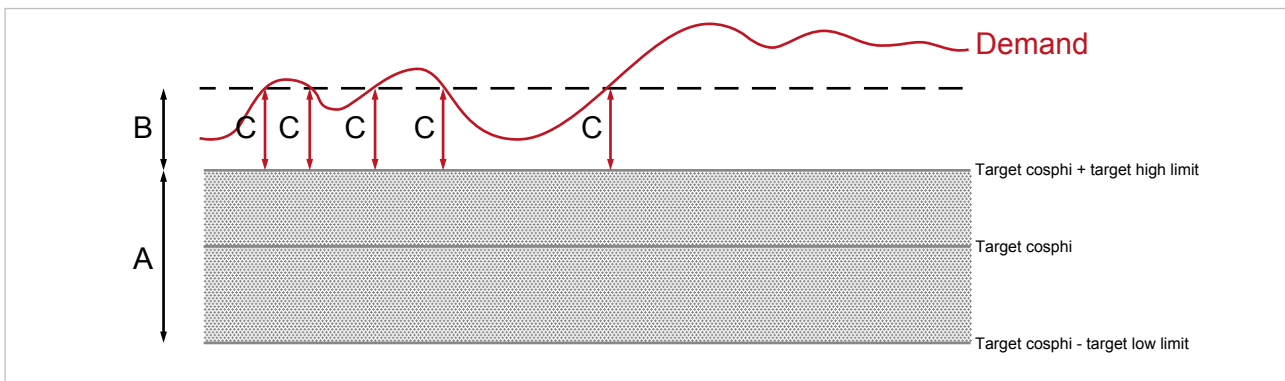

Fig. 3-26 RAPIDUS Mode Compensation Steps

On the diagram above:

A: Reactive power interval corresponding to the measured  $\text{Cos}\phi$  values.

B: Limit value decided for compensation by RAPIDUS (calculated as per automatic C/K ratio).

C: Reactive power value to be compensated.

When the system is in interval A, RAPIDUS does not compensate. When the system is in this interval, activation and deactivation counters of RAPIDUS are not active.

RAPIDUS starts to activate a step after an “activation time” (See 3.2.1.2.3.7 Activation time) when the system reactive power requirement reaches over B point.

Similarly, RAPIDUS starts to deactivate a step after a “deactivation time” (See 3.2.1.2.3.8 Deactivation time) when the system reactive power requirement is decreased under B point.

### 3.2.1.2.3.2.2 Ascending Sequential program



All steps (capacitor or reactor) shall have 3 phases in ascending sequential program.

Step activation and deactivation operations are performed by starting from the step with the lowest power (ascending sequential). When activation/deactivation is required, only one step is activated/deactivated. Then reactive power is calculated again. If activation/

deactivation demand is continued, next step with the lowest power is activated/deactivated.

• **When the System is Inductive**

If a shunt reactor is activated, RAPIDUS deactivates steps one by one until the demand is met starting with the shunt reactor with the lowest power.

Assume all shunt reactors are deactivated and system is still inductive. RAPIDUS activates steps starting with the capacitor step with the lowest power.

• **When the System is Capacitive**

If a capacitor is activated, RAPIDUS deactivates all steps one by one until the demand is met starting with the capacitor with the lowest power.

Assume all capacitors are deactivated and system is still capacitive. RAPIDUS activates steps starting with the shunt reactor step with the lowest power.

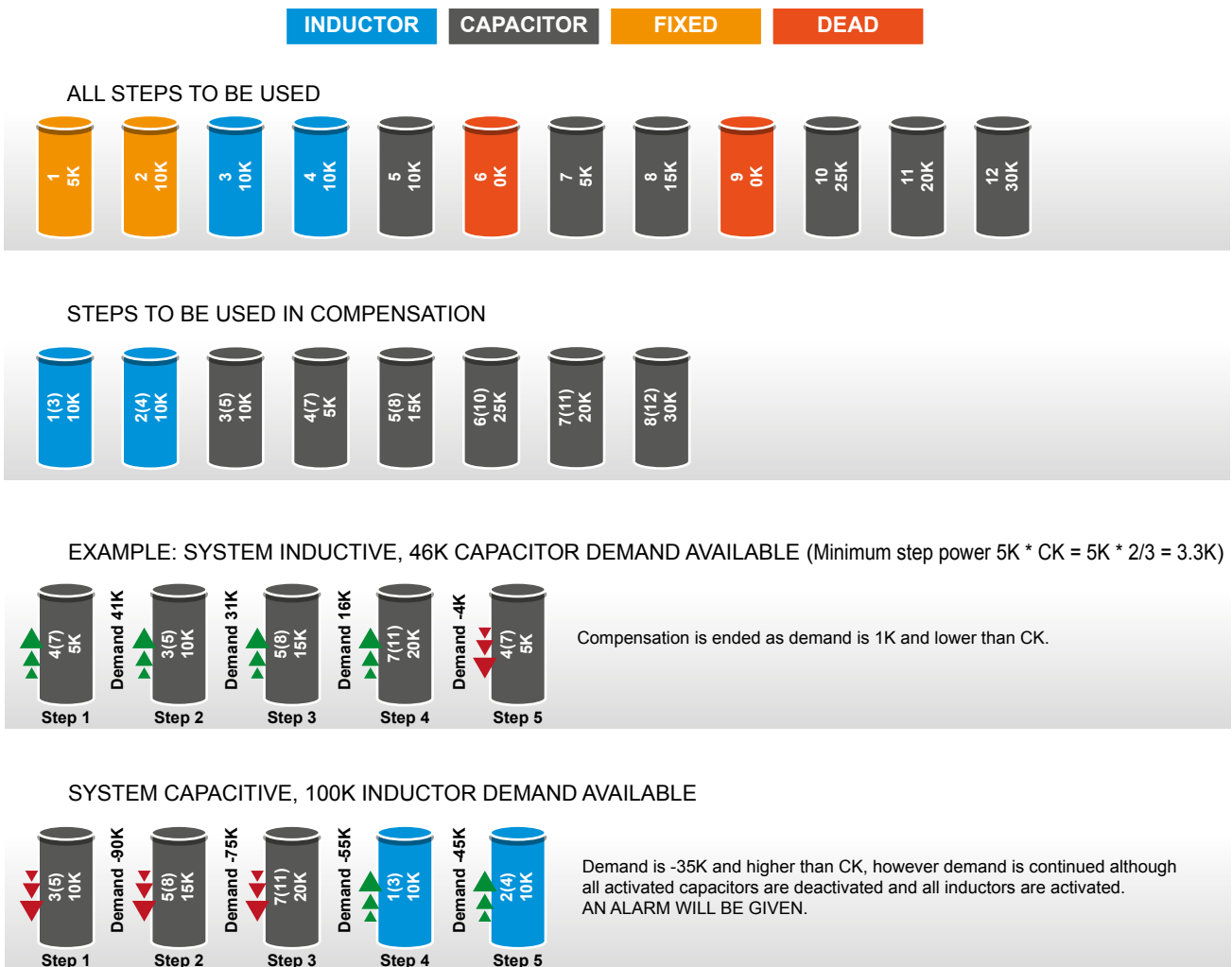

Fig. 3-27 RAPIDUS Asc. Sequential Mode



### 3.2.1.2.3.2.3 Descending Sequential Mode



All steps (capacitor or reactor) shall have 3 phases in descending sequential program.

RAPIDUS performs activation/deactivation operation starting with the step closest to the demand. When activation/deactivation is required, only one step is activated/deactivated. Then reactive power is calculated again. If activation/deactivation demand is continued, next step closest to the demand is activated/deactivated.

- **If the System is Inductive:**

If a shunt reactor is activated, steps are deactivated one by one until the demand is met starting with the shunt reactor closest to the demand.

If system is still inductive although all shunt reactors are deactivated, and there are capacitor steps that are not active, steps are activated one by one until the demand is met starting with the capacitor step closest to the demand.

- **If the System is Capacitive:**

If a capacitor is activated, steps are deactivated one by one until the demand is met starting with the capacitor closest to the demand.

If system is still capacitive although all capacitors are deactivated, and there are shunt reactor steps that are not active, steps are activated one by one until the demand is met starting with the shunt reactor step closest to the demand.

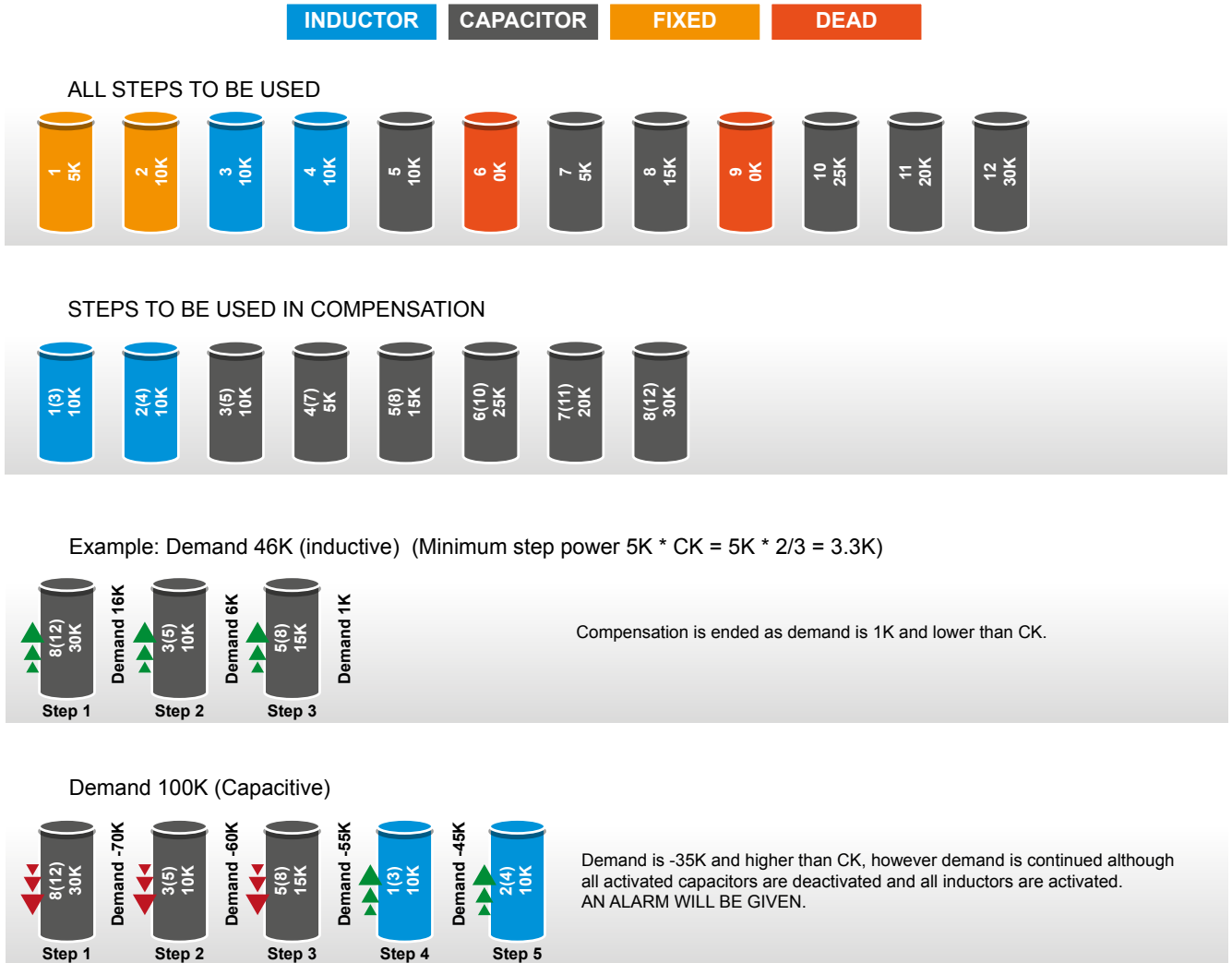

Fig. 3-28 RAPIDUS Des. Sequential Mode



### 3.2.1.2.3.2.4 Linear Mode



All steps (capacitor or reactor) shall have 3 phases in linear program.



Linear program is used in panels with the step structure 1.1.1.1.

The step activated first is deactivated last in linear program.

- **If the System is Inductive:**

If there are shunt reactors activated, the number of shunt reactors that will the demand shall be deactivated. If the system is still inductive although all shunt reactors are deactivated, the number of capacitors required shall be activated.

- **If the System is Capacitive:**

If there are capacitors activated, the number of capacitors that will the demand shall be deactivated. If the system is still capacitive although all capacitors are deactivated, the number of shunt reactors required shall be activated.

INDUCTOR

CAPACITOR

FIXED

DEAD

ALL STEPS TO BE USED

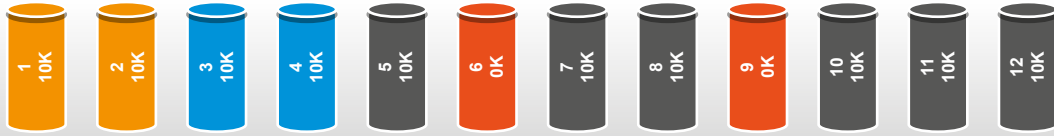

STEPS TO BE USED IN COMPENSATION

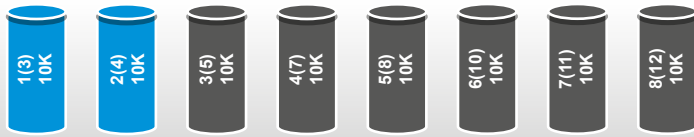

Example: SYSTEM INDUCTIVE, 46K CAPACITOR DEMAND AVAILABLE (Minimum step power  $10K * CK = 10K * 2/3 = 6.7K$ )

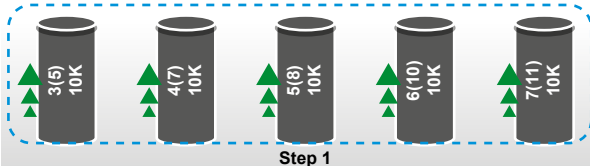

Compensation is ended as demand is -4K and lower than CK.

SYSTEM CAPACITIVE, 20K INDUCTOR DEMAND AVAILABLE

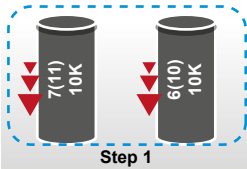

Compensation is ended as demand is 0K and lower than CK.

SYSTEM CAPACITIVE, 40K INDUCTOR DEMAND AVAILABLE

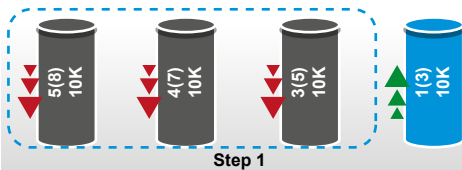

Compensation is ended as demand is 0K and lower than CK.

SYSTEM CAPACITIVE, 20K INDUCTOR DEMAND AVAILABLE

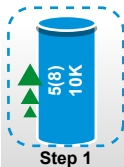

Compensation Demand is continued as demand is -10K and higher than CK. However, there are no inductors to activate nor capacitors to deactivate. AN ALARM WILL BE GIVEN.

Fig. 3-29 RAPIDUS Linear Mode



### 3.2.1.2.3.2.5 Circular Mode



All steps (capacitor or reactor) shall have 3 phases in circular program.



Circular program is used in panels with the step structure 1.1.1.1.

The step activated first is deactivated first in circular program.

- **If the system is inductive:**

If there are shunt reactors activated, the number of shunt reactors that will the demand shall be deactivated. If the system is still inductive although all shunt reactors are deactivated, the number of capacitors required shall be activated.

- **If the system is capacitive:**

If there are capacitors activated, the number of capacitors that will the demand shall be deactivated. If the demand is resumed although all capacitors are deactivated, the number of shunt reactors required shall be activated.

INDUCTOR    CAPACITOR    FIXED    DEAD

ALL STEPS TO BE USED

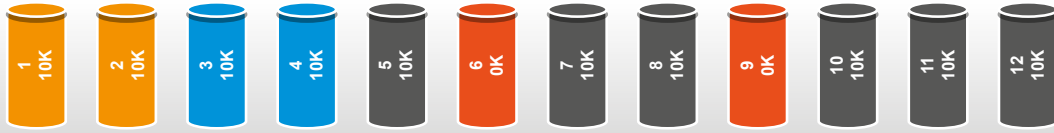

STEPS TO BE USED IN COMPENSATION

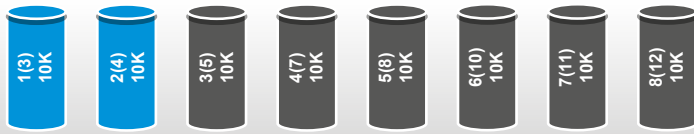

Example: SYSTEM INDUCTIVE, 46K CAPACITOR DEMAND AVAILABLE (Minimum step power  $10K * CK = 10K * 2/3 = 6.7K$ )

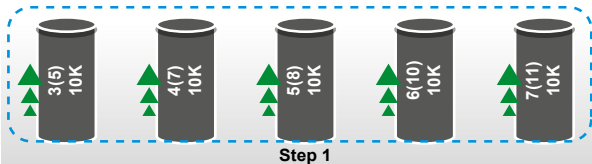

Compensation is ended as demand is -4K and lower than CK.

SYSTEM CAPACITIVE, 30K INDUCTOR DEMAND AVAILABLE

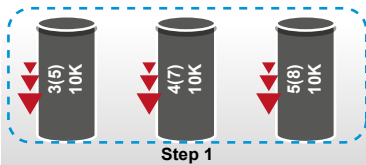

Compensation is ended as demand is 0K and lower than CK.

SYSTEM INDUCTIVE, 20K CAPACITOR DEMAND AVAILABLE

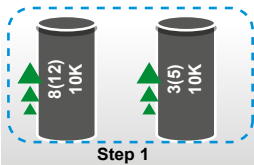

Compensation is ended as demand is 0K and lower than CK.

SYSTEM CAPACITIVE, 60K INDUCTOR DEMAND AVAILABLE

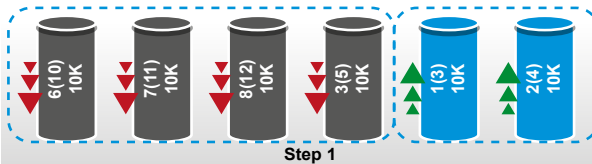

Compensation is ended as demand is 0K and lower than CK.

SYSTEM INDUCTIVE, 90K CAPACITOR DEMAND AVAILABLE

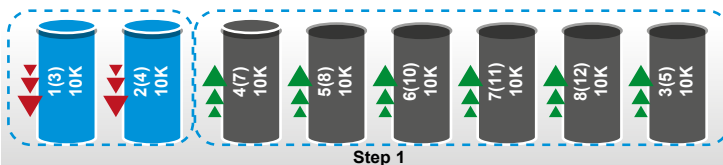

Demand is -10K, however, there are no inductors to activate nor capacitors to deactivate although the demand is continued. AN ALARM WILL BE GIVEN.

Fig. 3-30 RAPIDUS Circular Mode



### 3.2.1.2.3.2.6 Manual program



RAPIDUS does not perform automatic compensation when it is taken in manual mode.

When manual program is active, a “hand” symbol is displayed on the lower left corner of the main menu page. This symbol indicates that RAPIDUS is in manual compensation mode.

Manual mode is activated by pressing down arrow when you are in main menu screen. The step that shall be activated is highlighted with arrow keys and OK key is pressed. Thus, step shall be activated. Step shall be deactivated when you highlight the step that will be deactivated and press OK. If an hourglass symbol is displayed while the step is being activated, this indicates that discharge time is waited to activate the step.

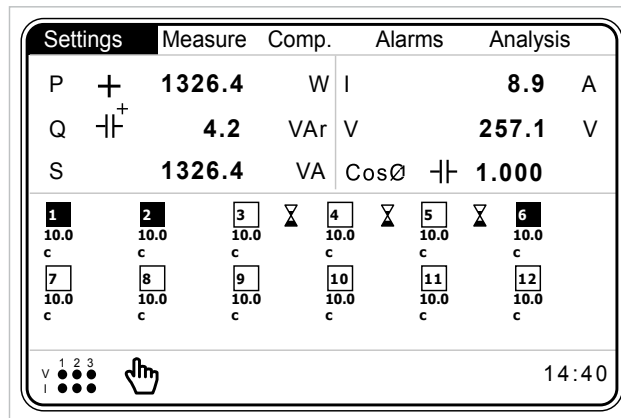

Fig. 3-31 Manual Mode Menu

If operator press down key, below screen is shown.

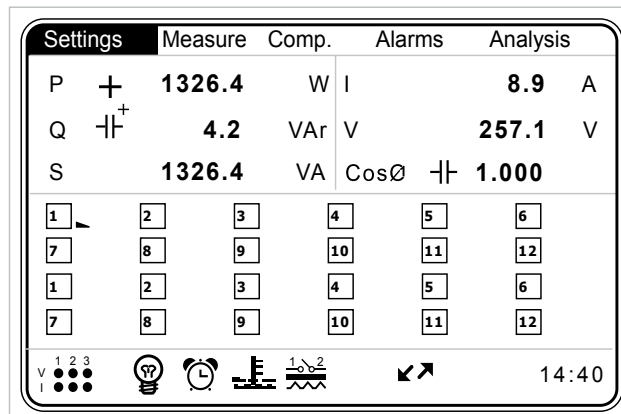

Fig. 3-32 RAPIDUS with 24 RELAYS

Operator can scroll inside steps by pressing right and left keys. When OK key is pressed below screen is shown. If operator press "OK" key again, the related step will be activated. The "v" symbol indicates the related relay is activated.

Settings	Measure	Comp.	Alarms	Analysis
P +	1326.4	W I		8.9 A
Q - +	4.2	VAr	V	257.1 V
S	1326.4	VA	CosØ - +	1.000
<b>Number 1</b> <b>Type C</b> ✓ <b>Power 10.00kVAr</b> <b>Switch 0</b> <b>Time 0</b>				
<span style="float: right;">14:40</span>				

Fig. 3-33 Step Information Screen for RAPIDUS 232R-E

### 3.2.1.2.3.3 Target 1 Menu

Target 1 CosΦ value is set here. It can be set between -0.800 and 0.800. Negative value indicates capacitive target, positive value indicates inductive target.

### 3.2.1.2.3.4 Target 2 Menu

Target 2 CosΦ value is set here. It can be set between 0.800 and 1.000. Positive value indicates inductive target.

For this feature to be active:

- Operator should change Mod tab of "Settings->Setup->Aux. input" setting to either of the following  
Night/day  
Generator
- GEN input should be activated with 85-265VAC.

### 3.2.1.2.3.5 Target Low Lim. Menu

It is the lower tolerance value for target 1 and target 2 settings. It can be set between 0.000 and 0.200.

### 3.2.1.2.3.6 Target High Lim. Menu

It is the upper tolerance value for target 1 and target 2 settings. It can be set between 0.000 and 0.200.



### 3.2.1.2.3.7 Activation Time Menu

RAPIDUS waits for the “activation time” before activating a step. Activation time may be selected between 1 and 600 seconds.

### 3.2.1.2.3.8 Deactivation Time Menu

RAPIDUS waits for the “deactivation time” before deactivating a step. Deactivation time may be selected between 1 and 600 seconds.

### 3.2.1.2.3.9 Shift Angle Menu

By entering the shift angle, changes in reactive power (transformer losses) that occur before the RAPIDUS measurement point are compensated.

Shift angle is set from  $-45^{\circ}$  to  $45^{\circ}$ . RAPIDUS adds the reactive power that is calculated with the shift angle to the reactive power that it calculates by measuring the system voltage and current. Then it calculates the  $\cos\phi$  value and compensates.

Index values vary as per shift angle.

#### Example 1:

Assume that the  $\cos\phi$  value indicated by RAPIDUS is 1.000.

When the user enters  $20^{\circ}$  as the shift angle, RAPIDUS shall calculate  $\cos\phi$  value as 0.940 inductive.

When the user enters  $-30^{\circ}$  as the shift angle, RAPIDUS shall calculate  $\cos\phi$  value as 0.866 capacitive.



### 3.2.1.2.3.10 Averaging Time

After accomplishing its measurements, RAPIDUS can quickly decide whether there is a need to switch in or out step(s). In summary, RAPIDUS is a quick responding reactive power controller.

If the operator does not require RAPIDUS to respond quickly, operator should adjust the device via this tab.

RAPIDUS takes average of the measured power during the adjusted interval (5 sec. – 60 sec.). Just after the adjusted time interval elapses, RAPIDUS compensates according to the calculated average power.

This setting will increase response time of RAPIDUS. However, on the other side, this setting will lengthen the lifetime of switch gear of the system. This is a compromise of opposite requirements, and it changes from system to system.”

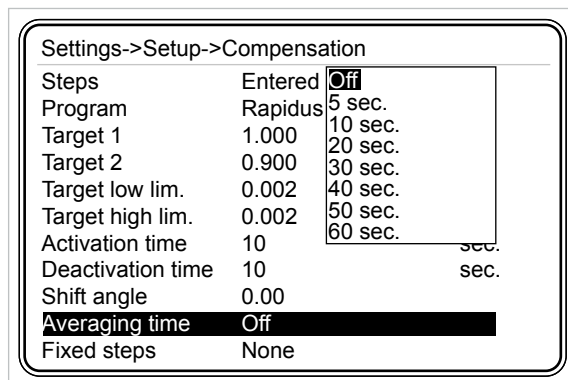

Fig. 3-34 Averaging Time Menu

### 3.2.1.2.3.11 Fixed Steps Menu

First three steps of RAPIDUS may be assigned as fixed steps. On the main menu screen, “↓” symbol is displayed next to the step assigned as fixed symbol.

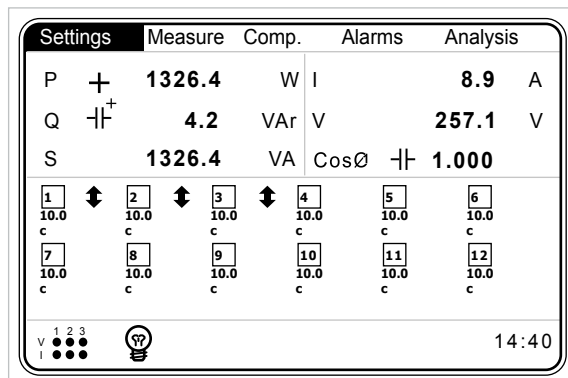

Fig. 3-35 Fixed Steps Menu

### 3.2.1.2.4 Learn Menu

Settings for learning of steps and connections by RAPIDUS are performed from this menu.

### 3.2.1.2.4.1 Learn Conn. Menu

Settings for learning of current and voltage connections by RAPIDUS are performed here.

#### 3.2.1.2.4.1.1 Learn at start

On => RAPIDUS learns connections automatically when it is turned on or restarted.

Off => RAPIDUS does not learn connections automatically when it is turned on or restarted.



If it is used as "On", connections are learned again and again when Rapidus is restarted or powered on. After connections are learned by Rapidus, it is highly recommended to use this setting as "Off". Otherwise connection can be learned wrongly.  
Besides, factory setting is "Off" as well.

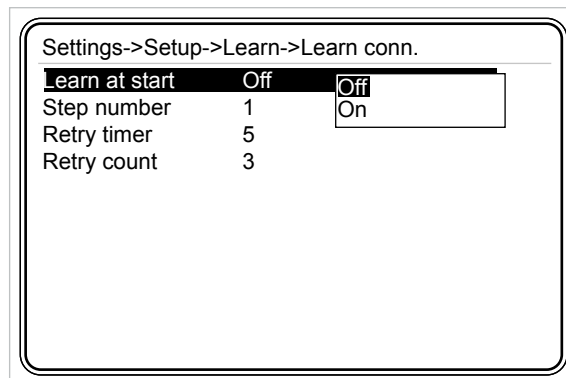

Fig. 3-36 Connection Setup

If the connections shall not be learned at start up, we advise them to be learned manually. This procedure is performed at "Compensation->Learn conn." menu. (See [3.2.3.4 Learn Conn. Menu](#))

Factory setting for connections is V1, V2, V3, I1, I2 and I3. RAPIDUS shall take a measurement with this combination in the initial start.



In cases where electrical system is unbalanced and/or there are sudden load changes, "learn algorithm" can be completed in an erroneous result. In such a situation, active powers measured by Rapidus will also be positive (checking active powers will not help).  
Therefore, it is important that operator should also physically check connections.

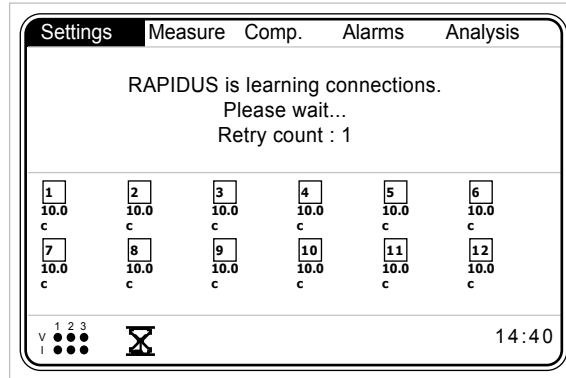

Fig. 3-37 Learning Connections at the Startup

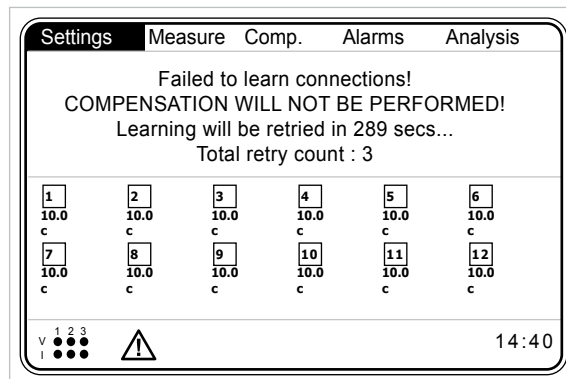

Fig. 3-38 Waiting Time After Unsuccessful Connection Learning

### 3.2.1.2.4.1.2 Step number

RAPIDUS learns the connections by activating a 3-phase capacitor.

We advise you to enter the step number that the capacitor with the highest power value is connected.



If the number of a step that is determined as faulty by RAPIDUS is entered to “Step number” setting, an error/warning message shall be displayed on the screen.

### 3.2.1.2.4.1.3 Retry Timer

If RAPIDUS could not learn the connection after making retries equal to the “Retry number”, it waits for the set retry timer without compensating. Then (after the “Retry timer”), it tries to learn the connections. This cycle is continued until the connections are learned.

While waiting for the “Retry timer”, RAPIDUS continues to make measurements and display these measurements on its screen, but it does not compensate.

If user does not want to wait during the retry timer, he/she can manually command from "Comp.->Learn conn.":

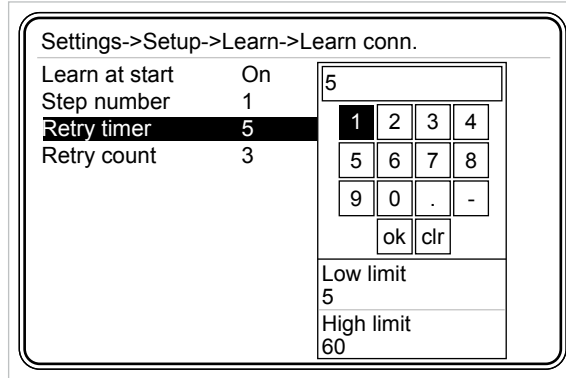

Fig. 3-39 Retry Timer

### 3.2.1.2.4.1.4 Retry Number

When it cannot learn the connection at startup, RAPIDUS it tries to learn the connections for times equal to the "Retry Number".

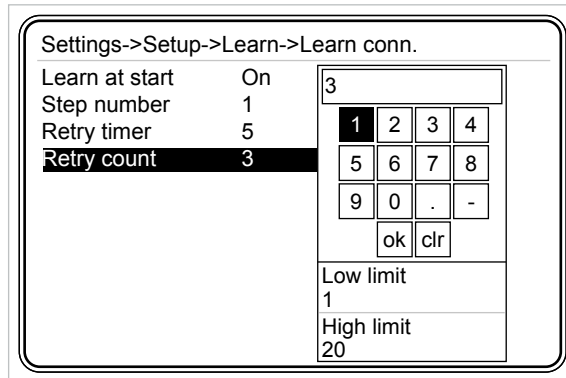

Fig. 3-40 Retry Count

### 3.2.1.2.4.2 Learn Step Menu

Settings for learning of current and voltage connections by RAPIDUS are performed here.

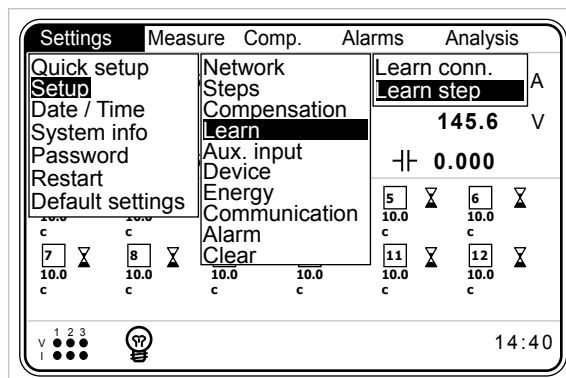

Fig. 3-41 Learn step

### 3.2.1.2.4.2.1 Learn at start

On => RAPIDUS learns step powers automatically when it is turned on or restarted.

Off => RAPIDUS does not learn step powers automatically when it is turned on or restarted.



If it is used as "On", step powers are learned again and again when Rapidus is restarted or powered on. After step powers are learned by Rapidus, it is highly recommended to use this setting as "Off". Otherwise step powers can be learned wrongly.

Besides, factory setting is "Off" as well.

### 3.2.1.2.4.3 Aux. Input Menu

Aux. input menu is used to ensure that, RAPIDUS compensates as per the secondary target  $\cos\phi$ .

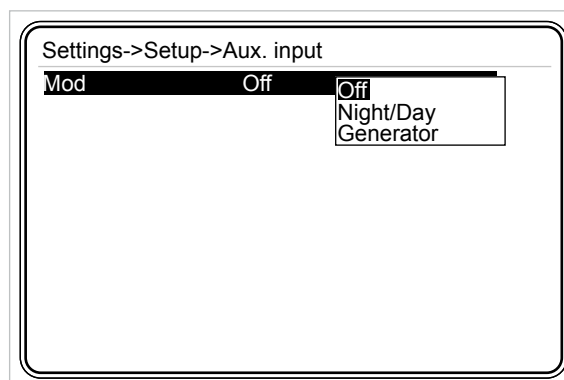

Fig. 3-42 Aux. Input

### 3.2.1.2.4.4 Off mode

If the digital input mode is selected as "Off", GEN input shall not affect running of RAPIDUS. RAPIDUS compensates as per "Target 1 value."

### 3.2.1.2.4.5 Night/Day Mode

If aux. input mode is selected as "Night/Day", compensation is performed as per "Target 2 value" when GEN input is active. Energy menu counters count independent of the GEN input.



### 3.2.1.2.4.6 Generator Mode

If aux. input mode is selected as “Generator”, compensation is performed as per the set “Target 2 value” when GEN input is active. Then, energy menu counters (See 3.2.2.2 Energy Menu) do not count.

### 3.2.1.2.5 Device Menu

This menu is used for performing the following settings.

- Language
- Contrast
- Pass. protection
- New password
- Display on
- Display on time

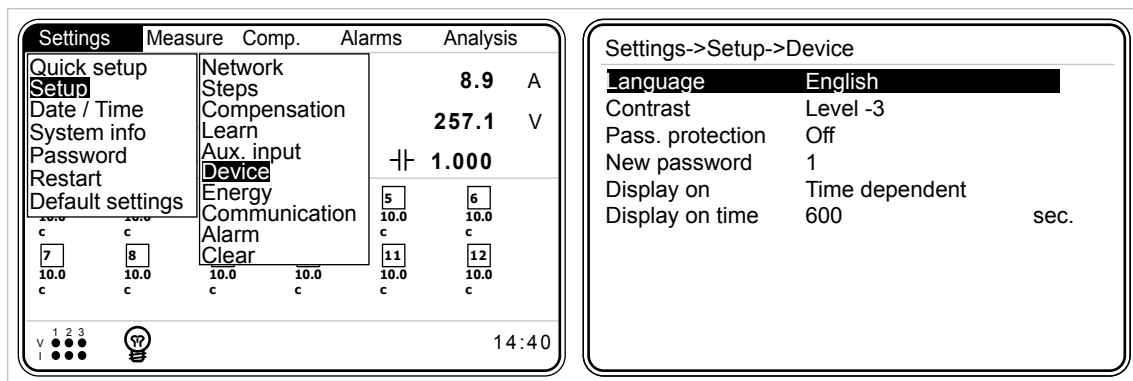

Fig. 3-43 Device Menu



### 3.2.1.2.5.1 Language Setting

- Türkçe
- English
- Русский

User shall select the desired setting with up and down arrows and press "OK".

### 3.2.1.2.5.2 Contrast Setting

This menu is used for performing the contrast setting. Level setting steps are displayed when you press OK when this option selected. User shall select the desired contrast level with up and down arrows and press "OK". RAPIDUS screen gets darker when you go up to level 4. RAPIDUS screen gets lighter when you go down to level -4.

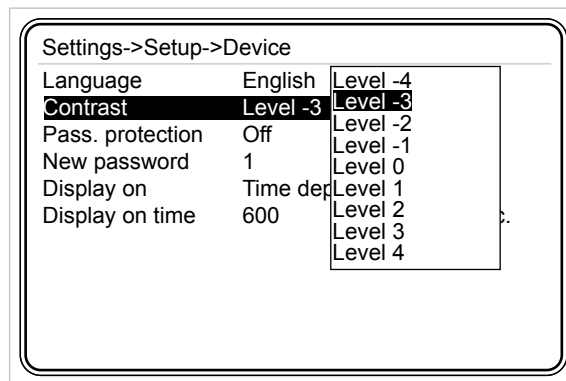

Fig. 3-44 Contrast Setting

### 3.2.1.2.5.3 Pass. Protection

If password protection is selected as "On", you shall enter a password in order to enter the setting menus each time RAPIDUS is restarted again.

If password protection is selected as "Off", you do not need to enter a password in order to enter the setting menus each time RAPIDUS is restarted again.

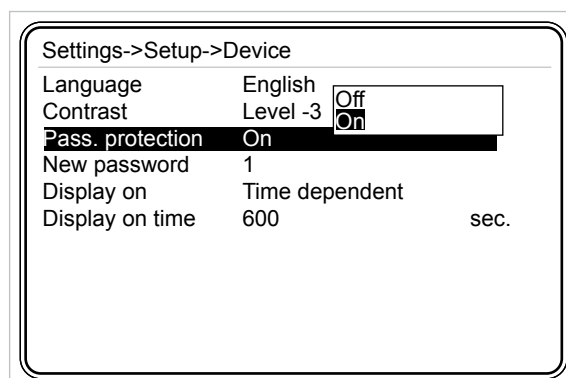

Fig. 3-45 Pass. Protection

### 3.2.1.2.5.4 New Password Setting

Factory set password of RAPIDUS is "1". New password may be selected between 1 and 9999. (For the usage of RAPIDUS Virtual Keyboard, [Refer to 3.1.4 Ex.](#))

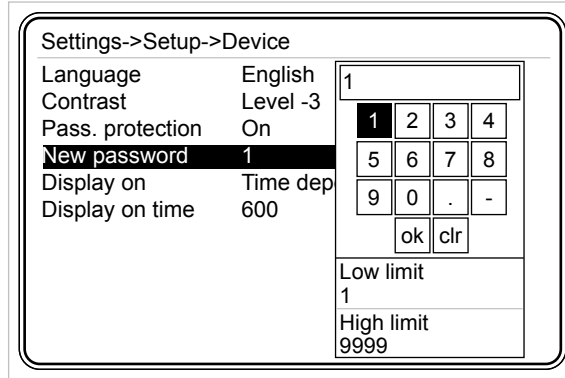

Fig. 3-46 New Password Entry

### 3.2.1.2.5.5 Display On Setting

- Continuous
- Time dependent

When continuous is selected, the backlight of RAPIDUS display does not turn off. When time dependent is selected, screen backlight is turned on for "display on time".

### 3.2.1.2.5.6 Display On Time Setting

This tab is used for setting the on time for the backlight of RAPIDUS display. It may be selected between 10 and 600 seconds. (For the usage of RAPIDUS Virtual Keyboard, [Refer to 3.1.4 Ex.](#))

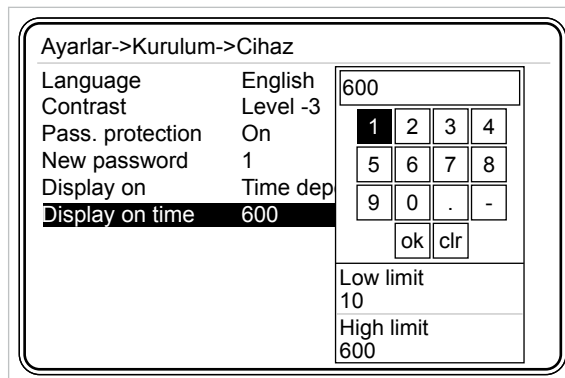

Fig. 3-47 Display On Time Setting



### 3.2.1.2.6 Energy Menu

This menu is used for entering the initial energy values. The settings in this menu are used for synchronization of system electricity counter and RAPIDUS counters. User shall select the desired energy value with up and down arrows and press "OK".

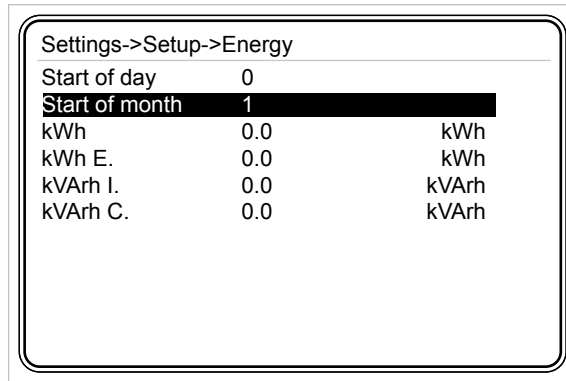

Fig. 3-48 Energy Menu

#### 3.2.1.2.6.1 Start of day setting

This is the settings tab for entering the time for start of the day. Start of the day time may be selected between 0 and 23. (For the usage of RAPIDUS Virtual Keyboard, [Refer to 3.1.4 Ex.](#))

#### 3.2.1.2.6.2 Start of month setting

This is the settings tab for entering the day for start of the month. Start of month day may be selected between 1 and 28. (For the usage of RAPIDUS Virtual Keyboard, [Refer to 3.1.4 Ex.](#))

-----

The settings listed below between 3.2.1.2.6.3 and 3.2.1.2.6.6 are used for synchronization of system electricity counter and RAPIDUS counter. Each of them may be set between 0.0 and 20000000000.0. (For the usage of RAPIDUS Virtual Keyboard, [Refer to 3.1.4 Ex.](#))

#### 3.2.1.2.6.3 kWh Setting

This tab is used for entering the "initial" value for imported active energy.

#### 3.2.1.2.6.4 kWh E. Setting

This tab is used for entering the "initial" value for exported active energy.

### 3.2.1.2.6.5 kVArh I. Setting

This tab is used for entering the “initial” value for inductive reactive energy.

### 3.2.1.2.6.6 kVArh C. Setting

This tab is used for entering the “initial” value for capacitive reactive energy.

### 3.2.1.2.7 Communication Menu

RAPIDUS includes Modbus RTU communication protocol. Settings related with Modbus protocol are made in this menu.

#### 3.2.1.2.7.1 Baud Rate Menu

User shall select the desired value with up and down arrows and press “OK”. RAPIDUS communicates with speeds of 2400, 4800, 9600, 19200, 38400, 57600 and 115200 bit/second.

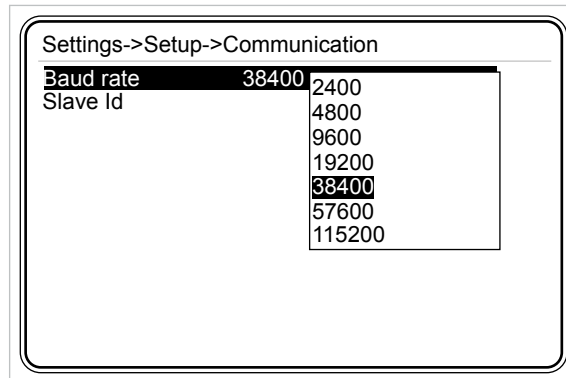

Fig. 3-49 Baud Rate Setting

#### 3.2.1.2.7.2 Slave Id Menu

This is the settings tab for entering the slave id number. (For the usage of RAPIDUS Virtual Keyboard, Refer to 3.1.4 Ex.).

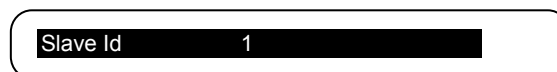

Fig. 3-50 Slave Id Setting

Maximum 247 devices may communicate over the same RS485 line. Therefore, slave id may be selected between 1 and -247.

### 3.2.1.2.8 Alarm Menu

User may navigate in the alarm settings menu using up and down arrow keys, and access the contents of the sub-menus of alarm menu by pressing OK.

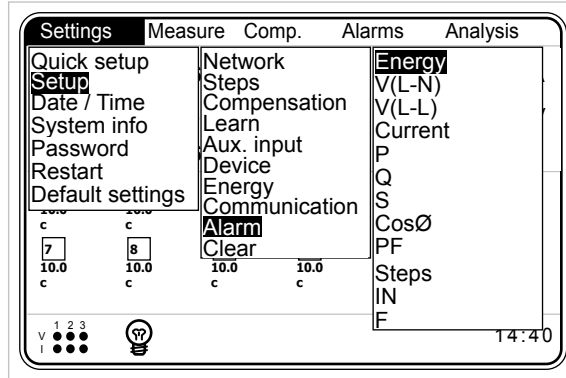

Fig. 3-51 Alarm Menu

#### 3.2.1.2.8.1 Energy Alarm Menu

This menu is used for performing the upper limit alarm settings of Inductive/Active and Capacitive/Active ratios. User may navigate in Energy alarms menu with up and down arrows.

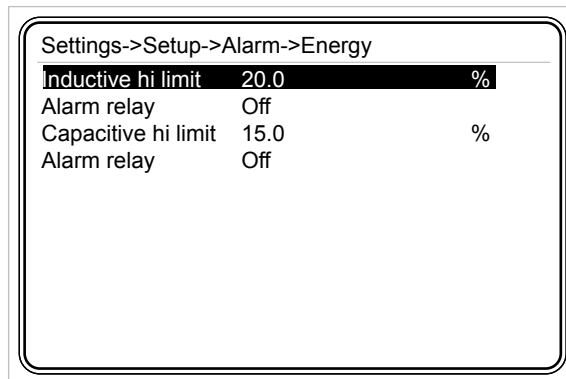

Fig. 3-52 Energy Menu

$$\text{Inductive hi limit} = \frac{\text{Inductive reactive energy}}{\text{Active energy}} \times 100$$

$$\text{Capacitive hi limit} = \frac{\text{Capacitive reactive energy}}{\text{Active energy}} \times 100$$

Refer to descriptions of V(L-N) Alarm menu for the alarm relay setting.

### 3.2.1.2.8.2 V(L-N) Alarm Menu

This sub-menu is used for phase-neutral voltage alarm settings. User may navigate in V(L-N) alarms menu with up and down arrows.

Settings->Setup->Alarm->V(L-N)		
Alarm relay	Off	
Low limit	0.0	V
High limit	0.0	V
Delay	0	sec.
Hysteresis	0.0	%

Fig. 3-53 V(L-N) Alarm Menu

#### Alarm relay:

This setting is used for regulation of pulling of the relays when an alarm occurred only. In order to ensure that RAPIDUS gives a V (L-N) alarm, lower and upper limit values shall be set as described below.

Alarm relay options:

Off: No alarm relay is pulled in case of an alarm

Relay1 : Only relay 1 is pulled in case of an alarm

Relay2 : Only relay 2 is pulled in case of an alarm

User shall select the desired setting with up and down arrows and press "OK".

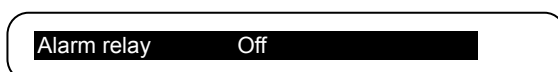

Fig. 3-54 Alarm Relay Setting

If V(L-N) in any of three phases goes out of low or high limit, RAPIDUS gives an alarm.

#### Low Limit:

This tab is used for entering alarm low limit. (For the usage of RAPIDUS Virtual Keyboard, Refer to 3.1.4 Ex.). In order to set an alarm for V (L-N) values, user shall enter a smaller low limit than high limit. If low limit and high limit values entered are the same, V(L-N) parameter is closed for alarms.

#### High Limit:

This tab is used for entering alarm high limit. (For the usage of RAPIDUS Virtual Keyboard, Refer to 3.1.4 Ex.). In order to set an alarm for V (L-N) values, user shall enter a higher high limit than low limit. If low limit and high limit values entered are the same, V(L-N) parameter is closed for alarms.

**Delay:**

RAPIDUS waits for the delay time before giving an alarm when the related alarm parameter exceeds “Low limit” or “High limit” value. Also, RAPIDUS waits for the delay time again before cancelling an alarm condition when the related alarm parameter returns back in the limits. It may be selected between 0 and 600 seconds. (For the usage of RAPIDUS Virtual Keyboard, [Refer to 3.1.4 Ex.](#)).

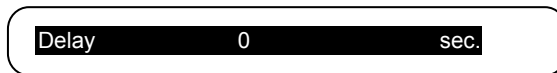

Fig. 3-55 Alarm Time Setting

**Hysteresis setting:**

This is the tolerance value entered in %. Refer to the example below and Fig. 3-56 for the usage method. It may be selected between 0.0 and 20.0. (For the usage of RAPIDUS Virtual Keyboard, [Refer to 3.1.4 Ex.](#))

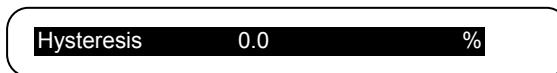

Fig. 3-56 Hysteresis Setting

**Example:**

For the figure below (delay setting is zero):

- An alarm occurs in point A
- Alarm is cancelled in point B
- An alarm occurs in point C
- Alarm is cancelled in point D

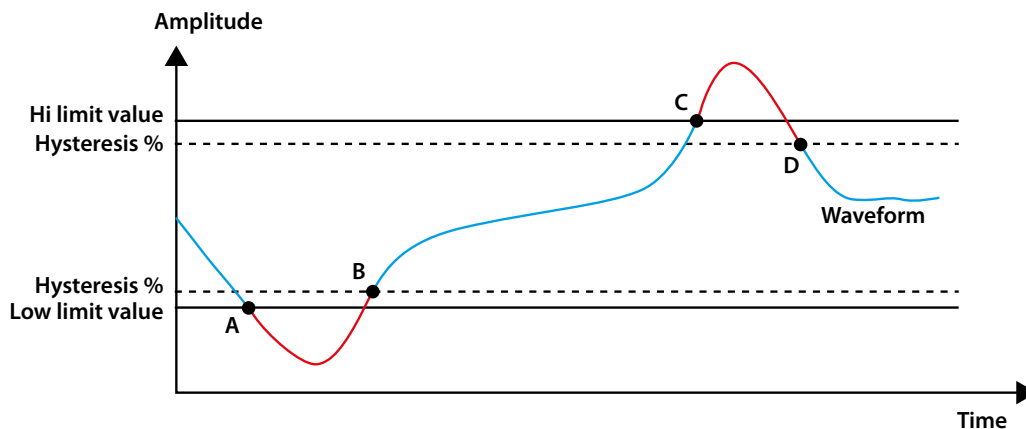

Fig. 3-57 Alarm Example





### 3.2.1.2.8.3 V(L-L) Alarm Menu

This sub-menu is used for phase-phase voltage alarm settings. Settings are the same for the settings for Alarm->V(L-N) menu. (V(L-L) low and high limit values: 0.0↔2600000.0).

### 3.2.1.2.8.4 Current Alarm Menu

This sub-menu is used for current alarm settings. Settings are the same for the settings for Alarm->V(L-N) menu. (Current low and high limit values: 0.0↔30000.0)

### 3.2.1.2.8.5 P Alarm Menu

This sub-menu is used for active power alarm settings. Settings are the same for the settings for Alarm->V(L-N) menu. (P low and high limit values: -10000000000.0↔10000000000.0)

### 3.2.1.2.8.6 Q Alarm Menu

This sub-menu is used for reactive power alarm settings. Settings are the same for the settings for Alarm->V(L-N) menu. (Q low and high limit values: -10000000000.0↔10000000000.0)

### 3.2.1.2.8.7 S Alarm Menu

This sub-menu is used for apparent power settings. Settings are the same for the settings for Alarm->V(L-N) menu. (S low and high limit values: 0.0↔10000000000.0)

### 3.2.1.2.8.8 CosØ Alarm Menu

This sub-menu is used for CosØ alarm settings. Settings are the same for the settings for Alarm->V(L-N) menu. (CosØ low and high limit values: 0.000↔1.000).

### 3.2.1.2.8.9 PF Alarm Menu

This sub-menu is used for power factor alarm settings. Settings are the same for the settings for Alarm->V(L-N) menu. (PF low and high limit values: 0.000↔1.000)

### 3.2.1.2.8.10 Step Alarm Menu

This sub-menu is used for step alarm settings. RAPIDUS gives an alarm when any of the steps used in compensation gets lower than the value calculated with the "low limit" setting (alarm limit).

$$\text{Alarm limit} = \frac{\text{initial value} \times \text{Low limit}}{100}$$

(Step low limit values: 20.0↔100.0)

### 3.2.1.2.8.11 IN Alarm Menu

This sub-menu is used for neutral current alarm settings. Settings are the same for the settings for Alarm->V(L-N) menu. (IN high limit values: 0.000↔30000.000)

### 3.2.1.2.8.12 F Alarm Menu

This sub-menu is used for frequency alarm settings. Settings are the same for the settings for Alarm->V(L-N) menu. (Frequency low and high limit values: 35.0↔70.0)

### 3.2.1.2.8.13 V Harmonics Alarm Menu

This sub-menu is used for harmonics alarm settings. User shall select the desired tab with up and down arrows and press "OK".

Settings->Setup->Alarm->Harmonics V		
Alarm relay	Off	Off
THDV hi limit	0.0	
V3 hi limit	0.0	Relay1
V5 hi limit	0.0	Relay2
V7 hi limit	0.0	%
V9 hi limit	0.0	%
V11 hi limit	0.0	%
V13 hi limit	0.0	%
V15 hi limit	0.0	%
V17 hi limit	0.0	%
V19 hi limit	0.0	%
V21 hi limit	0.0	%

Fig. 3-58 V Harmonics Alarm Menu

#### Alarm relay:

Refer to 3.2.1.1.8.1 V(L-N) - Alarm relay.

#### THDV High Limit:

This is used for entering high limit value of total harmonic distortion in the voltage. In order to set a THDV alarm, user shall enter a number higher than zero as THDV high limit. If zero is entered as the high limit value, THDV parameter is turned off for alarms.

It may be selected between 0.0 and 100.0. (For the usage of RAPIDUS Virtual Keyboard, Refer to 3.1.4 Ex.).

THDV hi limit	20.0	%
---------------	------	---

Fig. 3-59 THDV High Limit Setting

**V3 --- V21 high limit:**

This is used for entering high limit value of “3rd”, “5th” ... “21st” harmonic distortion in the voltage. In order to set a V3, V5 – V21 harmonic alarm, user shall enter a number higher than zero as high limit. If zero is entered as the high limit value, V3, V5 – V21 parameters are turned off for alarms.

It may be selected between 0.0 and 100.0. (For the usage of RAPIDUS Virtual Keyboard, Refer to 3.1.4 Ex.)

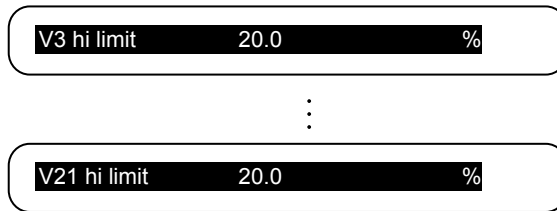

Fig. 3-60 V3-V21 Harmonics High Limit Setting

**Delay:**

Refer to 3.2.1.1.8.1 V(L-N) – Delay.

**3.2.1.2.8.14 I Harmonics Alarm Menu**

Settings for the “I harmonics” alarms are the same for the settings for “V harmonics”.

**3.2.1.2.8.15 Temperature Alarm Menu**

This sub-menu is used for temperature alarm settings. Settings are the same for the settings for Alarm->V(L-N) menu. (Temperature low and high limit values: It may be selected between -20.0 and 55.0).



If low limit and high limit values entered are the same, RAPIDUS does not give an alarm.

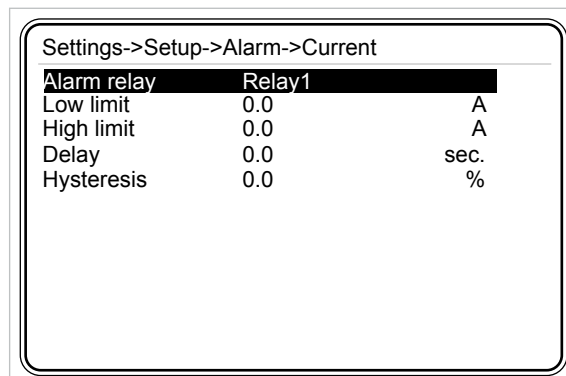

Fig. 3-61 No Alarm Time Condition



If low limit entered is higher than the high limit, "Invalid limits! Please check" message is displayed on RAPIDUS screen.

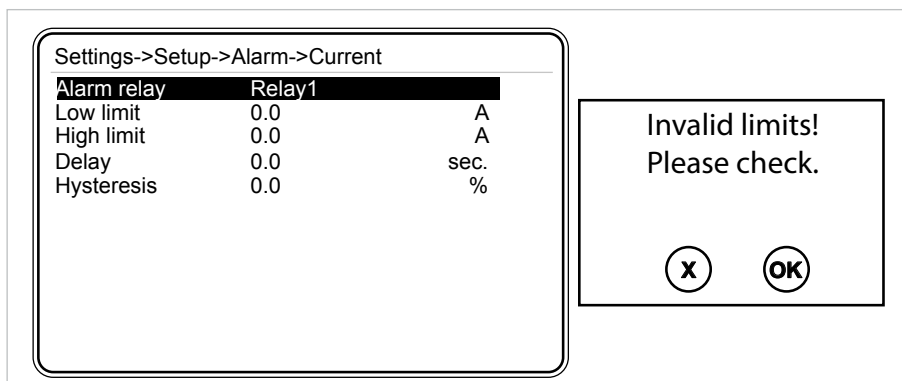

Fig. 3-62 Invalid Limit

### 3.2.1.2.9 Clear Menu

Sub menus are displayed when you press OK when the Clear option selected. User shall select the tab to be cleared with up and down arrows and press "OK". Relevant clearing operation is performed if you press OK when "Are you sure?" message is displayed on the screen; and it returns back without clearing when you press X.

Energy and demand values are cleared. Learned connections are returned back to factory presets.

All tab performs all of the three operations above.

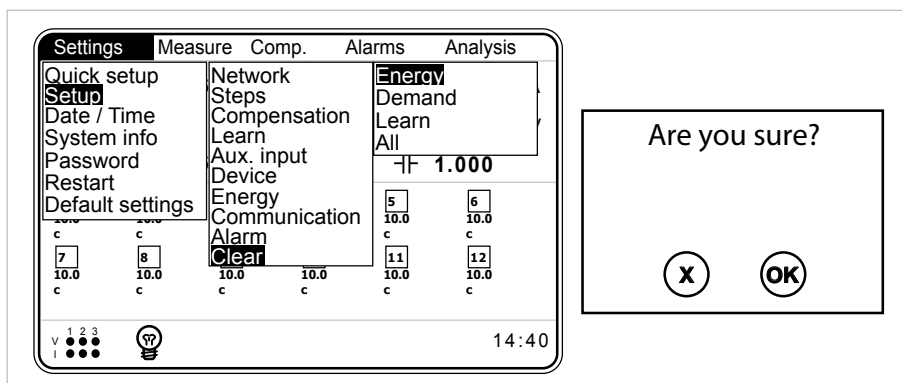

Fig. 3-63 Clear Menu

Assume that for a RAPIDUS used for some time, "Measure->Energy->Imp. Active" sub menu is like the one in Fig. 3-64.

Measure->Energy->Imp. active		
<b>Index</b>	<b>267500.1</b>	<b>kWh</b>
Curr. hour	0.5	kWh
Prev. hour	0.6	kWh
Curr. day	21.3	kWh
Prev. day	22.6	kWh
Curr. month	598.4	kWh
Prev. month	439.5	kWh

Fig. 3-64 Before Clearing

After the clearing operation is completed, "Measure->Energy->Imp. Active" sub menu shall be like the one in Fig. 3-65.

Measure->Energy->Imp. active		
<b>Index</b>	<b>0.0</b>	<b>kWh</b>
Curr. hour	0.0	kWh
Prev. hour	0.0	kWh
Curr. day	0.0	kWh
Prev. day	0.0	kWh
Curr. month	0.0	kWh
Prev. month	0.0	kWh

Fig. 3-65 After Clearing

After the clearing operation, a number different than zero may be seen for index parameters. This number is the initial value entered by the user for the relevant index parameter.

For example, assume that initial value for "Setup->Energy->T1 kWh" is entered as 7500 kWh. Then, after the clearing operation is completed, "Counters->Rate 1->Imp. Active->Index" value shall be 7500 kWh. (See Fig. 3-66)

Measure->Energy->Imp. active		
<b>Index</b>	<b>7500.0</b>	<b>kWh</b>
Curr. hour	0.0	kWh
Prev. hour	0.0	kWh
Curr. day	0.0	kWh
Prev. day	0.0	kWh
Curr. month	0.0	kWh
Prev. month	0.0	kWh

Fig. 3-66 Initial Value Entered After Clearing

### 3.2.1.3 Date/Time Menu

Date/Time is set in this menu. (For RAPIDUS Date/Time Setting, Refer to 3.1.4 Ex.).

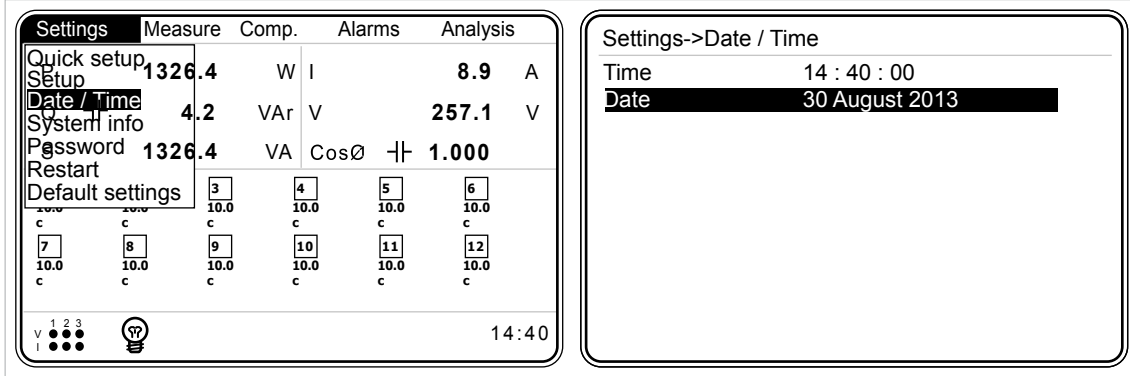

Fig. 3-67 Date/Time Menu

### 3.2.1.4 System Info Menu

No setting is performed in this menu, it is just for informational purposes.

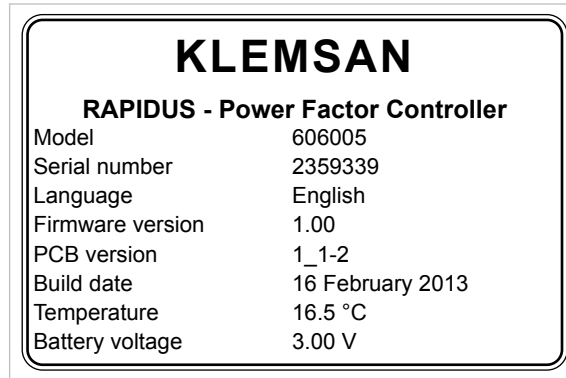

Fig. 3-68 System Info

Temperature and battery voltage values may be read via RS485.

### 3.2.1.5 Password Menu

If no password is entered, only Date/Time, System Info and Password tabs shall be active under settings menu. You shall enter a password in order to activate the other tabs.

“Login success” shall be displayed if the password entered is correct; and “Password mismatch” message shall be displayed if it is incorrect. (For the usage of RAPIDUS Virtual Keyboard, Refer to 3.1.4 Ex.).

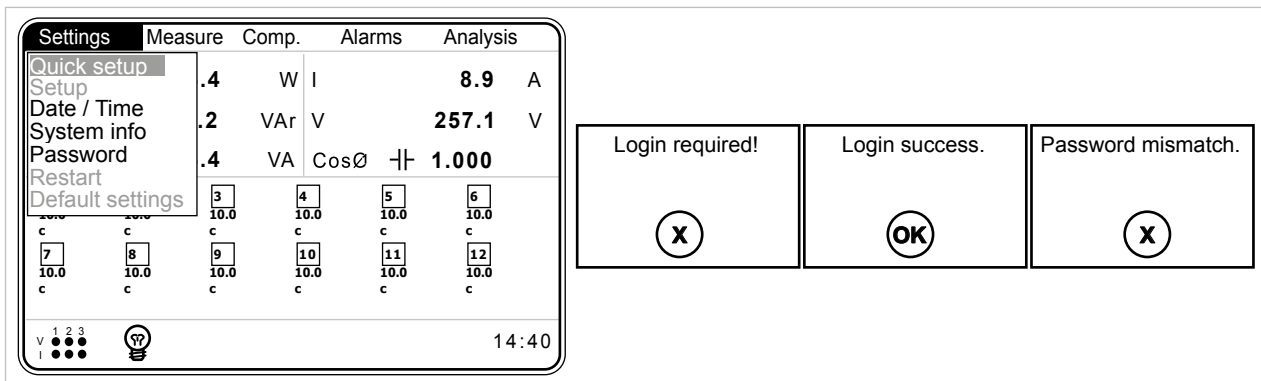

Fig. 3-69 Password

### 3.2.1.6 Restart Menu

This is used for restarting RAPIDUS. “Are you sure?” message shall be displayed if you press OK when the Restart tab is highlighted. RAPIDUS is restarted by pressing OK again.

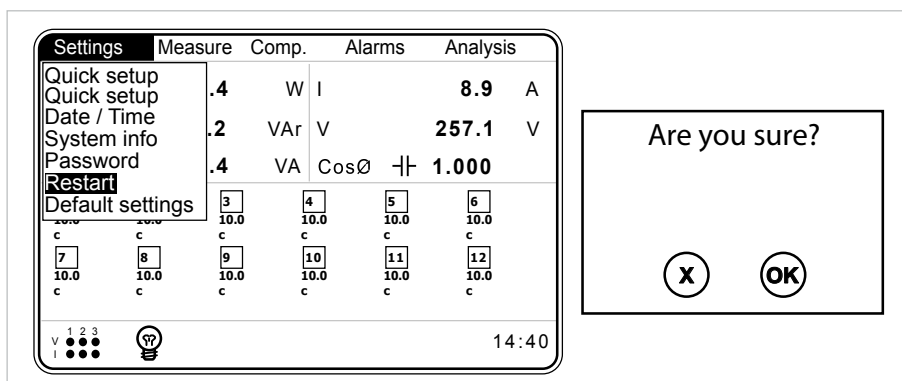

Fig. 3-70 RAPIDUS Restart

### 3.2.1.7 Default Settings

Default settings menu is used to return back to factory settings. After this operation, all settings other than date and time are returned back to factory settings.

Note: Index values are not reset after this operation.

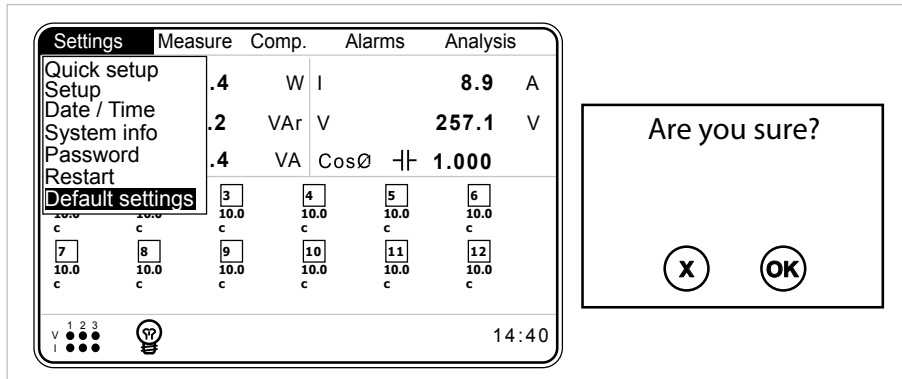

Fig. 3-71 Default Settings

### 3.2.2 Measure Menu

Sub-menus below are available under the measurements menu. User shall select the desired tab with up and down arrows and press "OK".

- Instantaneous
- Energy
- Demand
- Phasor diagram
- Harmonics

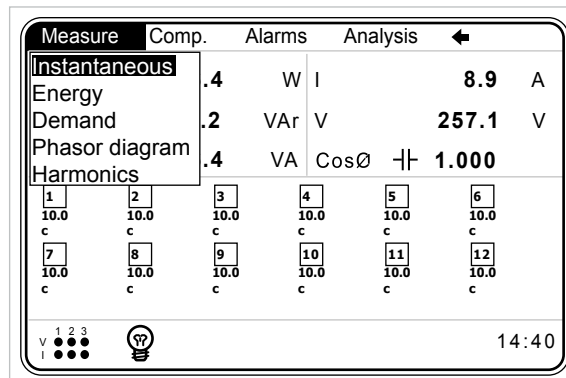

Fig. 3-72 Measure Menu





### 3.2.2.1 Instantaneous Menu

Instantaneous measurement values are available in this menu. Page in fig. 3-73 shall be displayed when OK is pressed while Measure menu, Instantaneous tab is highlighted. Instantaneous measurement parameters listed below are monitored using the right and left arrow keys.

Measure->Instantaneous->V L-N		
V1	220.0	V
V2	220.0	V
V3	220.0	V
V0	220.0	V
← Powers <b>V L-N</b> V L-L →		

Fig. 3-73 Instantaneous Menu

- Phase voltage (L-N) values and average voltage (L-N) value
- Phase voltage (L-L) values and average voltage (L-L) value
- Phase currents total current (I) value
- Neutral current (IN)
- CosØ values of phases and CosØ value of the system
- Power factor (PF) values of phases and total power factor (PF)
- Active power (P) values of phases and total active power (P) value
- Reactive power (Q) values of phases and total reactive power (Q) value
- Apparent power (S) values of phases and total apparent power (S) value
- Frequency (F) values of phases
- THDV values of phases and total THDV value
- THDI values of phases and total THDI value

### 3.2.2.2 Energy Menu

This menu includes

- Imported active
- Exported active
- Inductive reactive
- Capacitive reactive

energy values.



When an energy meter reaches the value "50000000.0 Mega", it will start to count from "0.0".

### 3.2.2.2.1 Imp. Active Menu (Imported Active Energy Menu)

Imported active energy values are displayed.

Measure->Energy->Imp. active		
Index	0.0	kWh
Curr. hour	0.0	kWh
Prev. hour	0.0	kWh
Curr. day	0.0	kWh
Prev. day	0.0	kWh
Curr. month	0.0	kWh
Prev. month	0.0	kWh

Fig. 3-74 Imp. Active Energy Page

#### Index

is the imported active energy value from the time when the energy values are cleared to this moment.

#### Curr. hour

is the imported active energy value from the start of the hour to this moment.

#### Prev. hour

is the active energy value imported during the previous hour.

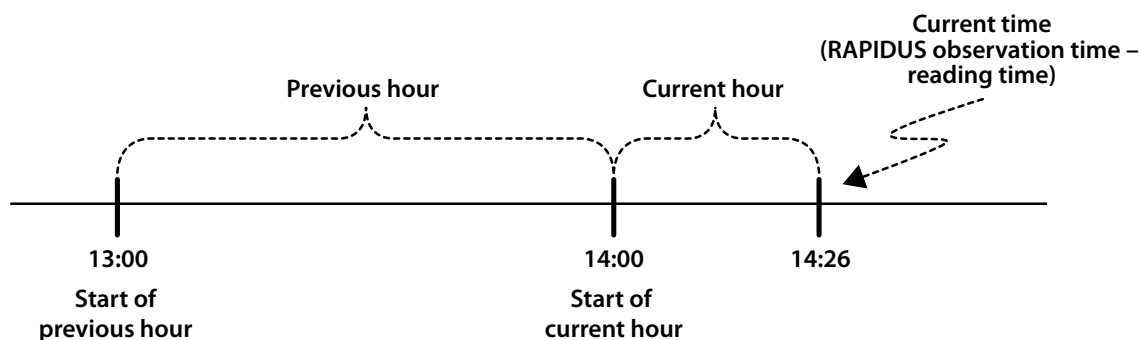

Fig. 3-75 Hour Start Example

**Curr. day**

is the imported active energy value from the starting hour of the day to this moment.

**Prev. day**

is the active energy value imported during the previous day.

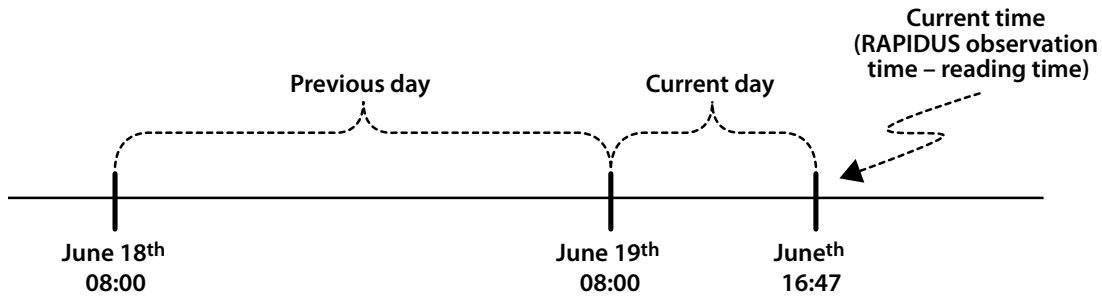

\*Starting hour of the day: 8

Fig. 3-76 Day Start Example

**Curr. month**

is the imported active energy value from the starting day of the month to this moment.

**Prev. month**

is the active energy value imported during the previous month.

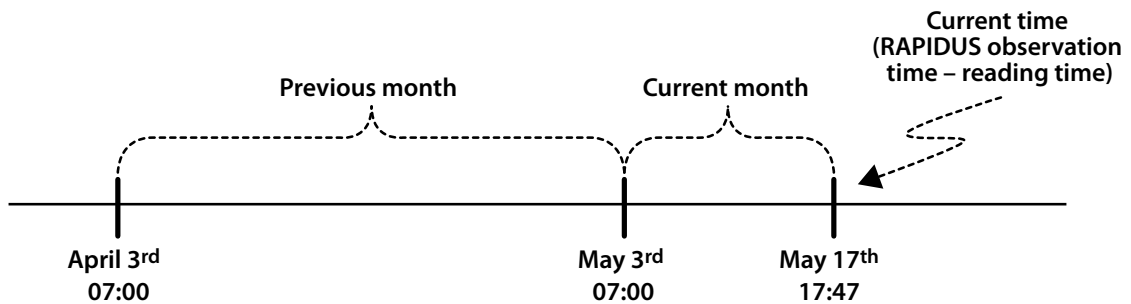

\*Starting hour of the day: 7  
\*Starting day of the month: 3

Fig. 3-77 Month Start Example

Settings for "start of day" and "start of month" parameters which are important for the usage of energy menu page are performed on "Settings->Setup->Energy" menu.

**Example:**

Assume that start of the day time is assigned as "0". Then, when the system clock shows 00:00, the value in the "Curr. day" tab shall be recorded in the "prev. day" tab. "Curr. day" shall be reset and starts to count from zero.

**Example:**

Assume that start of the month day is assigned as "1" and start of the day time is assigned as "0".

Then, when day of the moth is 1, and hour is 00:00, the value in the "Curr. month" tab shall be recorded in the "prev. month" tab. "Curr. month" shall be reset and starts to count from zero.

**3.2.2.2.2 Exp. Active Menu (Exported Active Energy Menu)**

The explanations for "Exp. active" menu are the same as 3.2.2.2.1 (Measure->Energy->Imp. Active) energy menu.

**3.2.2.2.3 Ind. Reactive Menu (Inductive Reactive Energy Menu)**

The explanations for "Ind. reactive" menu are the same as 3.2.2.2.1 (Measure->Energy->Imp. Active) energy menu.

**3.2.2.2.4 Cap. Reactive Menu (Capacitive Reactive Energy Menu)**

The explanations for "Cap. reactive" menu are the same as 3.2.2.2.1 (Measure->Energy->Imp. Active) energy menu.

**3.2.2.3 Demand Menu**

Highest values of the averages occurred in the currents and powers during the set demand period are displayed on the demand menu. Demand values are recorded with time information. On the demand sub menus, current and power values and sum of these values are shown for each phase.

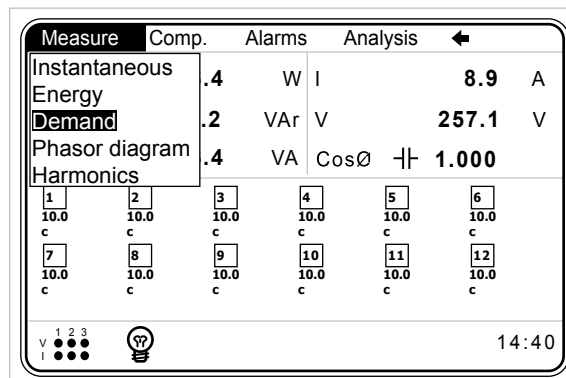
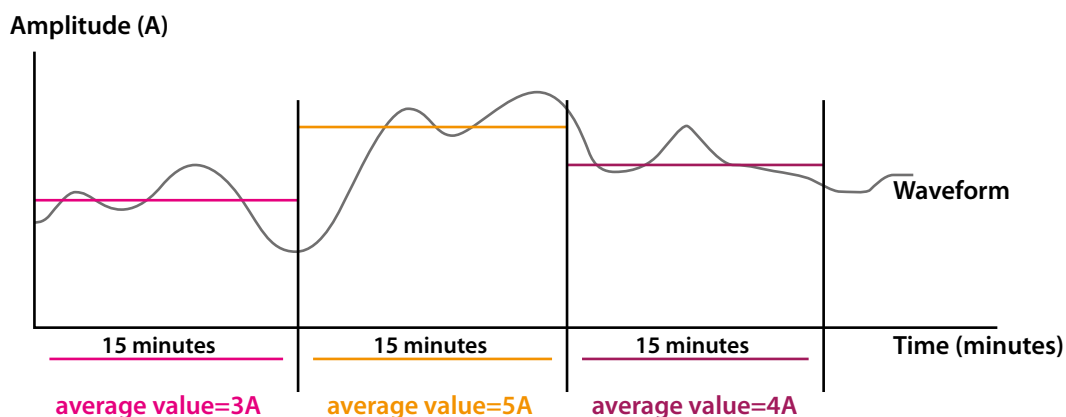

Fig. 3-78 Demand Menu

**Example:**

Current signal averages and demand value for 15 minutes demand period are shown in the following graphic.



average value=3A    average value=5A    average value=4A

demand period=15 minutes

Fig. 3-79 Demand Example

**3.2.2.3.1 Current Menu**

Demand values for each phase current and the demand value for the sum of the phase currents are shown. Bottom tab of the demand values indicate the date and time they have occurred.

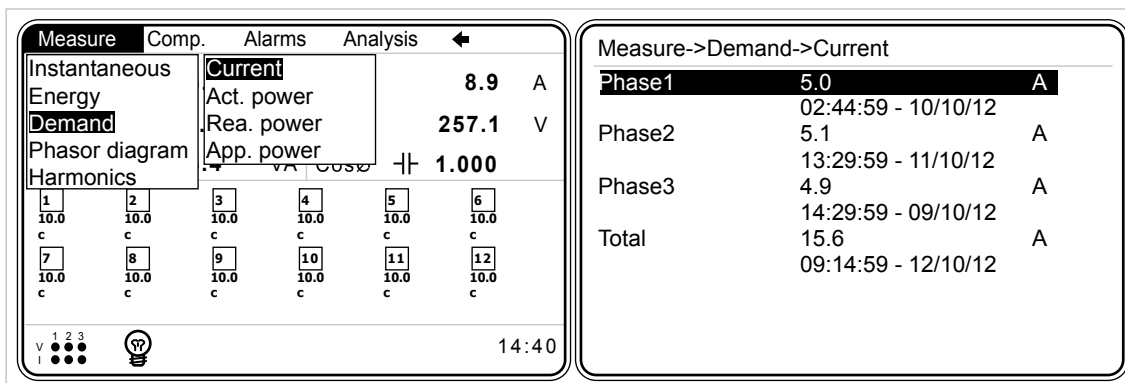

Fig. 3-80 Current Menu

**Example:**

Assume that the demand period is entered as 15 minutes and current value demand value and time are read as Phase1 5.0 A 02:44:59 - 10/10/13. Then, the description for the value read is as follows:

On October 10<sup>th</sup>, 2013, at 02:29:59 and 02:44:59 period, demand value for 1<sup>st</sup> phase is 5.0 A.

**Example:**

Demand periods when the demand period is set as 15 minutes when system clock is 15:07:00 are shown below:

05:07:00 - 15:14:59 = 1<sup>st</sup> demand period

15:14:59 - 15:29:59 = 2<sup>nd</sup> demand period

15:29:59 - 15:44:59 = 3<sup>rd</sup> demand period

15:44:59 - 15:59:59 = 4<sup>th</sup> demand period

15:59:59 - 16:14:59 = 5<sup>th</sup> demand period

·  
·  
·

**3.2.2.3.1.1 Act. Power Menu**

Demand values in the active power sub menu are as described in "Measure->Demand->Current" sub menu.

**3.2.2.3.1.2 Rea. Power Menu**

Demand values in the reactive power sub menu are as described in "Measure->Demand->Current" sub menu.

**3.2.2.3.1.3 App. Power Menu**

Demand values in the apparent power sub menu are as described in "Measure->Demand->Current" sub menu.

**3.2.2.4 Phasor diagram Menu**

Following information are listed on the right side of the diagram on phasor diagram menu screen.

- voltage values for phases
- current values for phases
- Angle values between V1-V2, V2-V3 and V3-V1
- Angle values between V1-I1, V2-I2 and V3-I3

On the phasor diagram, current lines are displayed as gray and voltage lines are displayed as black.

In order to follow the currents and voltages pertaining to the same phase more easily in phasor diagram, circles with the same size are added to the ends of the lines pertaining to the same phase.

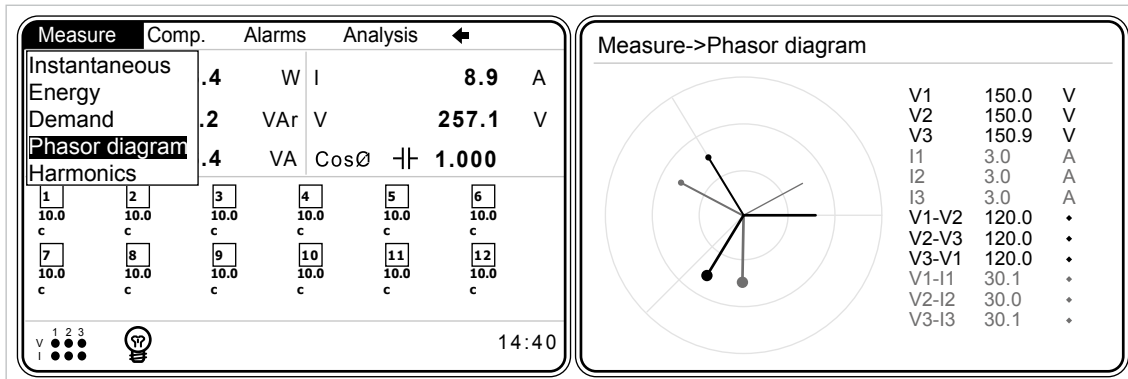

Fig. 3-81 Phasor Diagram Menu

### 3.2.2.5 Harmonics Menu

RAPIDUS measures/calculates current and voltage harmonics up to 51st level. Current and voltage harmonics are displayed both in tabular and graphic form.

#### 3.2.2.5.1 Table Menu

Current and voltage harmonics pertaining to each phase are displayed in tabular form in this menu (See Fig. 3-82). User may navigate between tables by pressing right and left arrows.

There are 6 table pages. V1, V2, V3, I1, I2, I3.

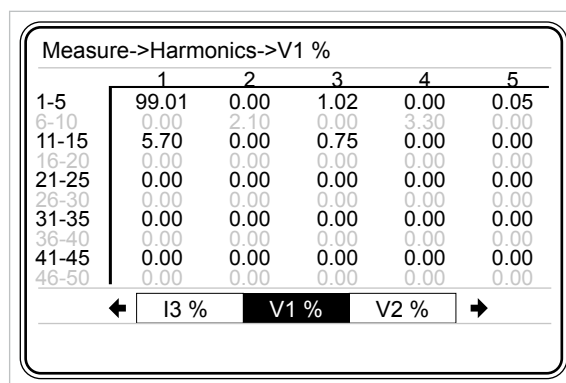

Fig. 3-82 Harmonics Table Menu

### 3.2.2.5.2 Graphic Menu

Current and voltage harmonics pertaining to each phase are displayed in graphic form in this menu (See Fig. 3-83). User may navigate between current-voltage graphics by pressing right and left arrows. There are 6 graphic pages: V1, V2, V3, I1, I2, I3.

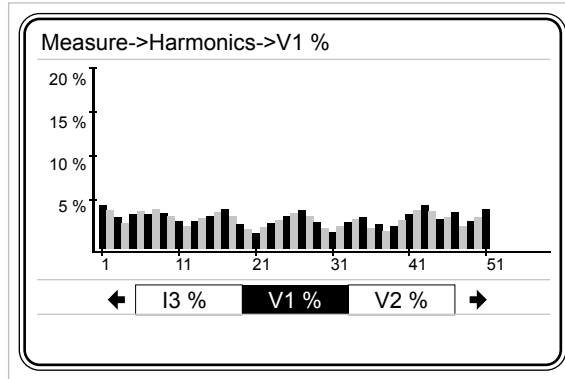

Fig. 3-83 Graphic Menu

### 3.2.3 Comp. (Compensation) Menu

Sub menus shown in Fig. 3-84 are available.

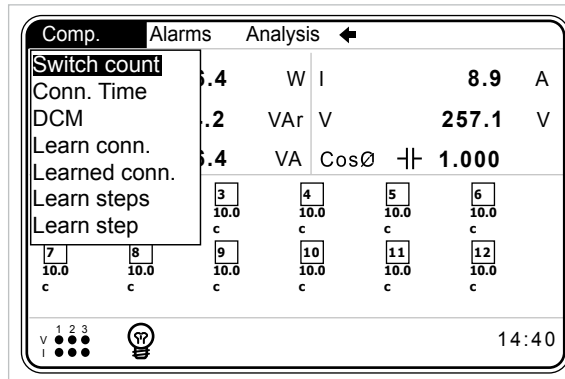

Fig. 3-84 Comp. Menu





### 3.2.3.1 Switch Count Menu

This menu displays how many times RAPIDUS activated each step.

In order to clear/change switching counts, highlight the desired step and press OK. Switch count is set between 0 and 10000. (For the usage of RAPIDUS Virtual Keyboard, Refer to 3.1.4 Ex.).

Comp.->Switch count	
Step 1	0
Step 2	0
Step 3	0
Step 4	0
Step 5	0
Step 6	0
Step 7	0
Step 8	0
Step 9	0
Step 10	0
Step 11	0
Step 12	0

**NOTE:** There are two "Switch Count" submenus for RAPIDUS 232R-E. Operator can assign 1<sup>st</sup>, 2<sup>nd</sup>, ... and 12<sup>th</sup> step powers in "Switch Count 1" Submenu. Operator can assign 13<sup>th</sup>, 14<sup>th</sup>, ...and 24<sup>th</sup> step powers in "Switch Count 2" Submenu.

Fig. 3-85 Switch Count

### 3.2.3.2 Conn. Time Menu

Connection times of the steps are displayed.

In order to clear/change connection times, highlight the desired step and press OK. Conn. time is set between 0 and 1000000. (For the usage of RAPIDUS Virtual Keyboard, Refer to 3.1.4 Ex.).

Comp.->Conn. time		
Step 1	0	min
Step 2	0	min
Step 3	0	min
Step 4	0	min
Step 5	0	min
Step 6	0	min
Step 7	0	min
Step 8	0	min
Step 9	0	min
Step 10	0	min
Step 11	0	min
Step 12	0	min

**NOTE:** There are two "Conn. Time" submenus for RAPIDUS 232R-E. Operator can assign 1<sup>st</sup>, 2<sup>nd</sup>, ... and 12<sup>th</sup> step powers in "Conn. Time 1" Submenu. Operator can assign 13<sup>th</sup>, 14<sup>th</sup>, ...and 24<sup>th</sup> step powers in "Conn. Time 2" Submenu.

Fig. 3-86 Conn. Time

### 3.2.3.3 DCM (Dynamic Capacitor Monitoring)

Step values learned by dynamic monitoring can be followed from this menu. These are observed after a certain amount of time due to the effects and nature of DCM algorithm.

There is no compensation program with a prerequisite for DCM. DCM shall estimate step powers in each compensation program.

First estimation results require at least 128x8 compensation switching. Estimation values shall be updated at every 128 compensation switching after that. Previous estimation power is the entered or learned step power values.

If one of estimated step value(that is defined by DCM algorithm) is lower than 20% of previous value or higher than 180% of previous value, related step won't be used in compensation.

In this situation, related step and its connection must be checked.

*NOTE: DCM(Dynamic Capacitor Monitoring) feature isn't available in RAPIDUS 232R-E optional model.*

### 3.2.3.4 Learn Conn. Menu

Connections of current and voltage measurement inputs are learned.

RAPIDUS learns the connections by activating a 3-phase capacitor. Relevant capacitor is determined with the "Step number" tab on the 'Quick Setup' or 'Settings->Setup->Learn->Learn Conn.' menu.

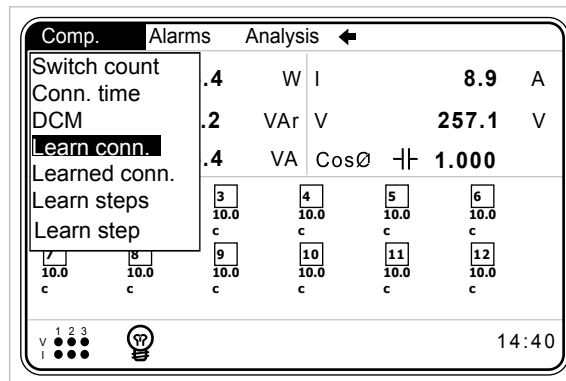

Fig. 3-87 Learn Conn.



If "3.2.1.2.4.1.1 Learn at start of" is set as "On", connections are learned again and again when Rapidus is restarted or powered on. After connections are learned by Rapidus, it is recommended to use that setting as "Off". Otherwise connection can be learned wrongly.



On the "Step number" setting, the step number that the capacitor with the highest power value is connected shall be entered.

### 3.2.3.5 Learned Conn. Menu

Connections learned by RAPIDUS are displayed.

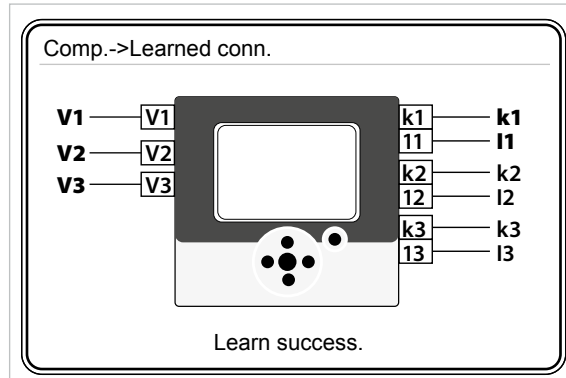

Fig. 3-88 Learned Conn. Example-1

#### Explanation of Fig. 3-88

Voltage lines of network;

Phase 1; is connected to V1 terminal of Rapidus.

Phase 2; is connected to V2 terminal of Rapidus.

Phase 3; is connected to V3 terminal of Rapidus.

Current lines of network;

Phase 1; is connected to I1 terminal of Rapidus correctly(I1,k1).

Phase 2; is connected to I2 terminal of Rapidus correctly(I2,k2).

Phase 3; is connected to I3 terminal of Rapidus correctly(I3,k3).

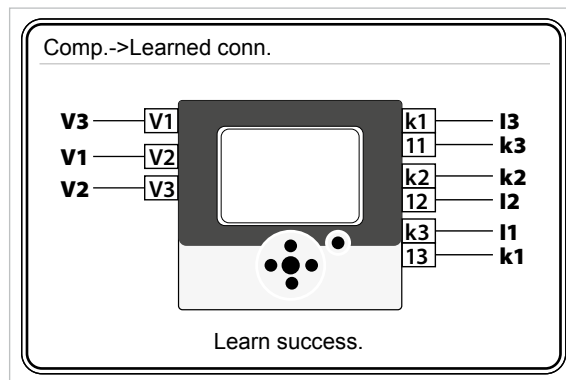

Fig. 3-89 Learned Conn. Example-1

#### Explanation of Fig. 3-89

Voltage lines of network;

Phase 1; is connected to V2 terminal of Rapidus.

Phase 2; is connected to V3 terminal of Rapidus.

Phase 3; is connected to V1 terminal of Rapidus.

Current lines of network;

Phase 1; is connected to I3 terminal of Rapidus reversly(I1,k1).

Phase 2; is connected to I2 terminal of Rapidus correctly(k2,I2).

Phase-3; is connected to I1 terminal of Rapidus reversly(I3,k3).

### 3.2.3.6 Learn Steps Menu

RAPIDUS learns the power and type of capacitors or shunt reactors connected to its steps by activating them in order.

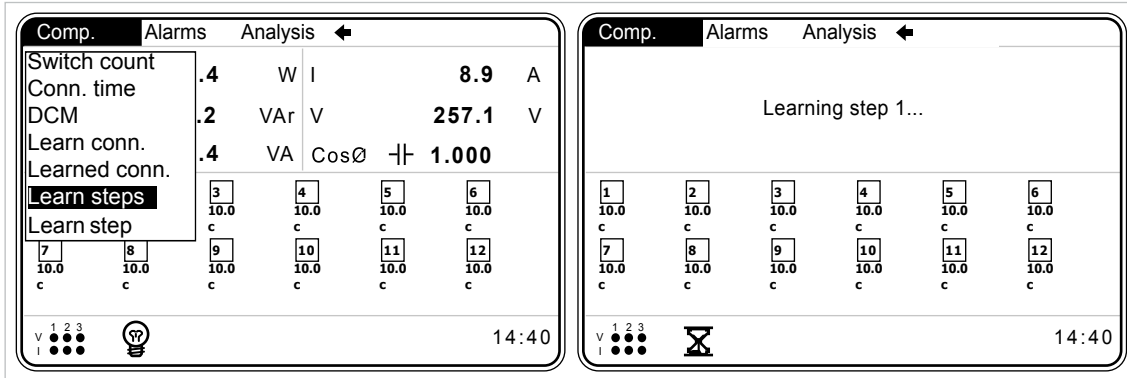

Fig. 3-90 Learn Steps



No load (current amplitude and  $\cos\phi$ ) changes shall occur in the system to ensure that step powers are learned correctly. Otherwise, RAPIDUS may learn step powers and step types incorrectly.

### 3.2.3.7 Learn Step Menu

RAPIDUS learns specified step power and its type by this menu.

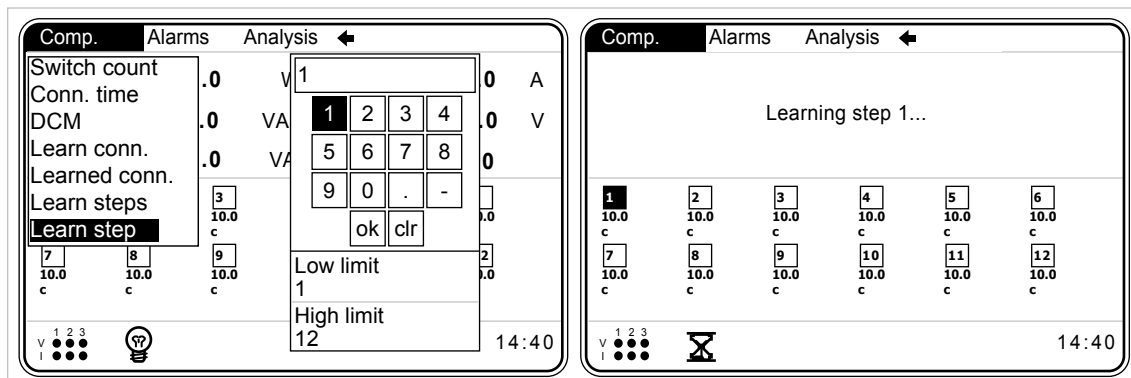

Fig. 3-91 Learn Step

### 3.2.4 Alarms Menu

RAPIDUS alarms may be monitored from alarms menu. Sub menus are Phase1, Phase2, Phase3, Step and Other.

A total of 50 alarm conditions with their times are recorded on the RAPIDUS MODBUS table. When the number of alarm conditions exceed 50, last occurring alarm conditions is written over the 1st alarm.

On the MODBUS table, the descriptions for the variables related with the alarm conditions are as follows:

Alarm Timestamp : Carries alarm time information. It has 32 bit int. data structure.

**Alarm Description** : This is the bit number on the alarm tags. Thus, user may match the relevant bit on the alarm tag and the alarm. Refer to the example.

**Alarm Status** : Indicates alarm entry or alarm exit status. Both alarm entry and alarm exit are events for RAPIDUS. Both are recorded in MODBUS table.

1 -> Alarm entry  
0 -> Alarm exit

**Alarm Value** : Current value of the parameter related with the alarm  
For more details, refer to Modbus document.

**Example:**

Assume 100 VAC is entered as the low limit value for phase1, phase2 and phase3 voltages and phase3 voltage has gone under 100VAC in the system. In this case,

Alarm Description is the index number of the relevant alarm bit in the alarm tags. Thus, for the condition above, "alarm description value" shall be 3.

Briefly, you can use the number under this heading as an index in the alarm tags to reach the description of alarm. Moreover, user matches the alarm and alarm tag.

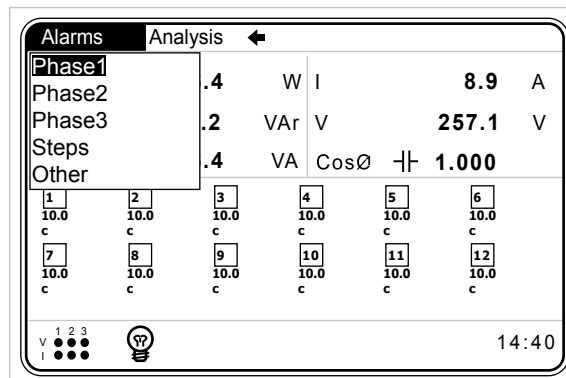

Fig. 3-92 Alarms Menu

**3.2.4.1 Phase1 Menu**

Statuses of alarms pertaining to 1<sup>st</sup> phase are shown in Phase1 menu.

"Normal" → NO Alarm

"Alarm" → Alarm AVAILABLE

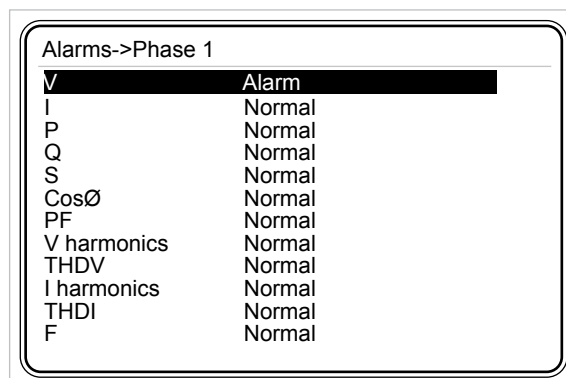

Fig. 3-93 Phase1 Menu

Following alarm statuses are monitored in Phase1 menu.

- V (phase-neutral voltage)
- I (current)
- P (active power)
- Q (reactive power)
- S (apparent power)
- CosØ
- PF (power factor)
- V harmonics (up to 21st voltage harmonics)
- THDV voltage (total harmonics distortion in the voltage)
- I harmonics (up to 21st current harmonics)
- THDI (total harmonics distortion in the current)
- F (frequency)

### 3.2.4.2 Phase2 Menu

Phase2 menu descriptions are the same as the Phase1 menu descriptions.

### 3.2.4.3 Phase3 Menu

Phase3 menu descriptions are the same as the Phase1 menu descriptions.

### 3.2.4.4 Step Menu

Descriptions of Normal and Alarm warnings are the same as Phase1 menu in “Step” menu.

RAPIDUS gives an alarm when any of the steps used in compensation gets lower than the value calculated with the “low limit” setting (alarm limit).

Alarms->Steps	
Step 1	Normal
Step 2	Normal
Step 3	Normal
Step 4	Normal
Step 5	Normal
Step 6	Normal
Step 7	Normal
Step 8	Normal
Step 9	Normal
Step 10	Normal
Step 11	Normal
Step 12	Normal

Fig. 3-94 Step Menu

### 3.2.4.5 Other Menu

Descriptions of Normal and Alarm warnings are the same as Phase1 menu in “Other” menu.

Alarms->Other	
<b>Under comp.</b>	<b>Normal</b>
Over comp.	Normal
Ind. energy	Alarm
Cap. energy	Alarm
VLL12	Normal
VLL23	Normal
VLL31	Normal
IN	Normal
Temperature	Normal
Battery	Normal

Fig. 3-95 Other Menu

Following alarm statuses are observed in “Other” menu.

- Under comp.
- Over comp.
- Ind. energy
- Cap. energy
- VLL12 (phase1-phase2 voltage)
- VLL23 (phase2-phase3 voltage)
- VLL31 (phase3-phase1 voltage)
- IN (Neutral current)
- Temperature
- Battery

When the battery voltage is less than 1.9V, RAPIDUS gives a battery alarm. When RAPIDUS gives a battery alarm, please contact the authorized dealer you have purchased the device (or nearest authorized dealer).

### 3.2.5 Analysis Menu

This menu contains sub menus shown in [Fig. 3-96](#).

Analysis menu parameters can be read from MODBUS table.

Analysis					
Minimum	.4	W	I	8.9	A
Maximum					
Average	.2	VA <sub>r</sub>	V	257.1	V
Energy	.4	VA	Cos $\phi$	1.000	
1	2	3	4	5	6
10.0	10.0	10.0	10.0	10.0	10.0
c	c	c	c	c	c
7	8	9	10	11	12
10.0	10.0	10.0	10.0	10.0	10.0
c	c	c	c	c	c
					14:40

Fig. 3-96 Analysis Menu



Analysis menu parameters are not stored in nonvolatile memory. Therefore, all parameters pertaining to analysis menu are reset when the device is reset.

### 3.2.5.1 Minimum Menu

This menu includes hourly, daily and monthly minimum values.

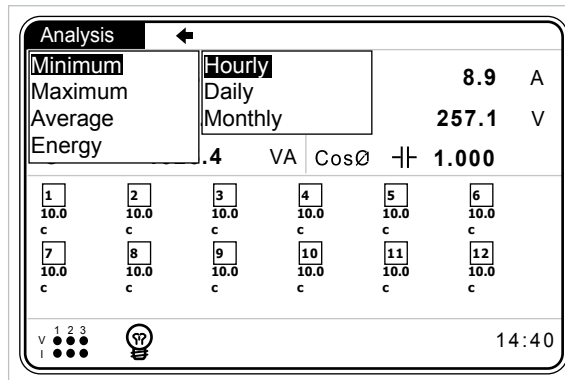

Fig. 3-97 Minimum Menu

#### 3.2.5.1.1 Hourly Menu

This menu includes minimum 'instantaneous' values measured from the start of the hour to current time.

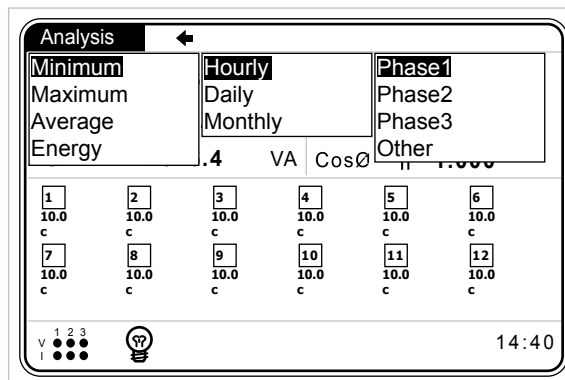

Fig. 3-98 Hourly Menu

##### 3.2.5.1.1.1 Phase1 Menu

Voltage (V), current (I), active power (P), reactive power (Q), apparent power (S),  $\cos\phi$ , power factor (PF) and frequency (F) values are displayed.

##### 3.2.5.1.1.2 Phase2 Menu

Voltage (V), current (I), active power (P), reactive power (Q), apparent power (S),  $\cos\phi$ , power factor (PF) and frequency (F) values are displayed.





### 3.2.5.1.1.3 Phase3 Menu

Voltage (V), current (I), active power (P), reactive power (Q), apparent power (S),  $\cos\phi$ , power factor (PF) and frequency (F) values are displayed.

### 3.2.5.1.1.4 Other

VLL12 (phase1-phase2 voltage), VLL23 (phase2-phase3 voltage), VLL31 (phase3-phase1 voltage)

### 3.2.5.1.2 Daily Menu

This menu includes minimum “instantaneous” values measured from the starting hour of the day ([Refer to 3.2.1.2.6.1](#)) to current time. Descriptions of sub menus are the same as the hourly menu.

### 3.2.5.1.3 Monthly Menu

This menu includes minimum “instantaneous” values measured from the starting day of the month ([Refer to 3.2.1.2.6.2](#)) and starting hour of the day ([Refer to 3.2.1.2.6.1](#)) to current time. Descriptions of sub menus are the same as the hourly menu.

### 3.2.5.2 Maximum Menu

Sub menus and descriptions of the sub menus of the “Maximum” menu are the same as “Minimum” menu. Values measured in “Maximum” menu are also “instantaneous” maximum values.

### 3.2.5.3 Average Menu

Sub menus and descriptions of the sub menus of the “Average” menu are the same as “Maximum” menu. “Average” menu displays the “average” values taken in hourly, daily and monthly periods.

### 3.2.5.4 Energy Menu

This menu includes hourly, daily and monthly counter values.

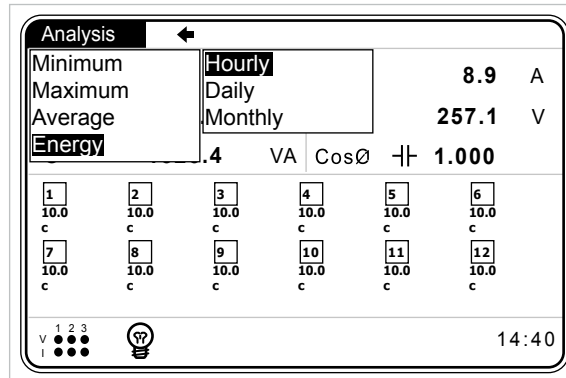

Fig. 3-99 Energy Menu

#### 3.2.5.4.1 Hourly Menu

This menu includes counter values measured from the start of the hour to current time. kWh (imp. active), kWh E. (exp. active), kVArh I (inductive reactive), kVArh C. (capacitive reactive) counter values are displayed.

#### 3.2.5.4.2 Daily Menu

This menu includes counter values measured from the starting hour of the day ([Refer to 3.2.1.2.6.1](#)) to current time.

kWh (imp. active), kWh E. (exp. active), kVArh I (inductive reactive), kVArh C. (capacitive reactive) counter values are displayed.

#### 3.2.5.4.3 Monthly Menu

This menu includes counter values measured from the starting day of the month ([Refer to 3.2.1.2.6.2](#)) and starting hour of the day ([Refer to 3.2.1.2.6.1](#)) to current time.

kWh (imp. active), kWh E. (exp. active), kVArh I (inductive reactive), kVArh C. (capacitive reactive) counter values are displayed.



**RAPIDUS**

Power Factor  
Controller

**SECTION 4  
MODBUS  
PROTOCOL**

## SECTION 4 MODBUS PROTOCOL

### 4.1 RS485 Wiring Diagram

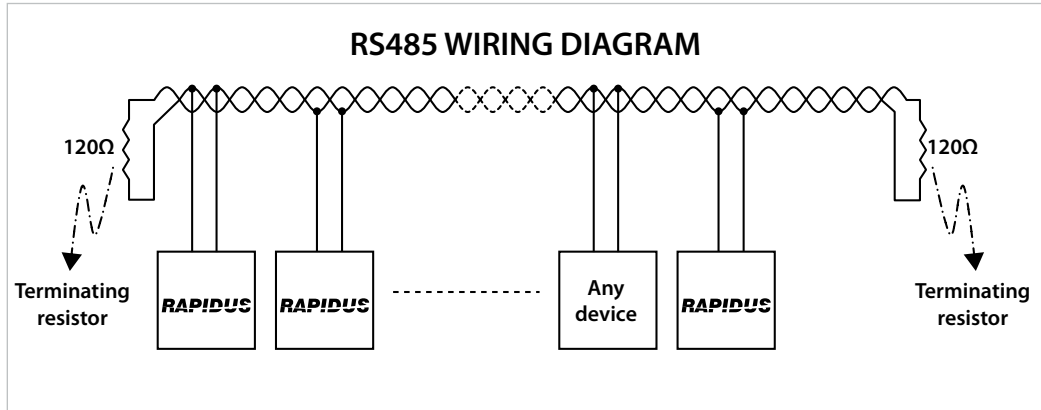

Figure 4-1 RS485 Wiring Diagram

### 4.2 Computer Connection

RAPIDUS can communicate with PCs via USB-RS85 or RS232-RS485 converters.

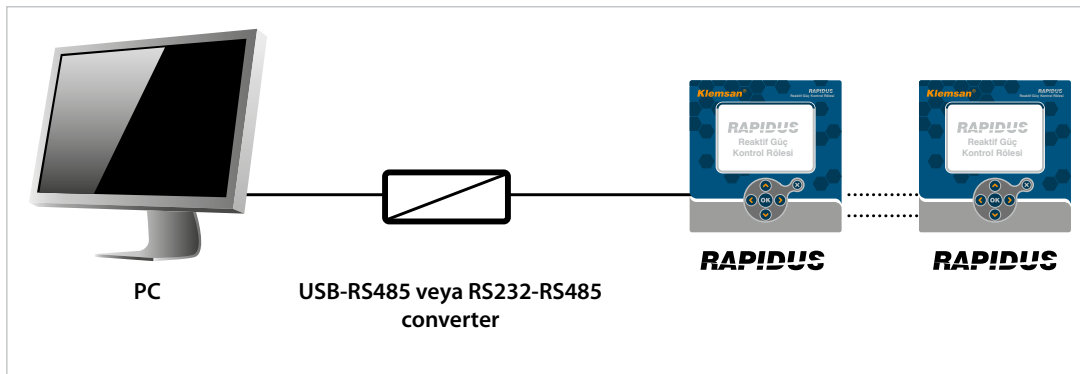

Figure 4-2 RS485 PC Connection



### 4.3 Message Format and Data Types of MODBUS-RTU Protocol

RAPIDUS, implements modbus RTU protocol. Modbus RTU message format is as follows.

Table 4-1 Message Format

Start	Address	Function	Data	CRC	End
≥ 3.5 byte	1 byte	1 byte	0-252 byte	2 byte	≥ 3.5 byte

There should be a time gap, which is at least 3.5 characters wide, between RTU messages.

For instance, when client device requests any information, server device should reply after at least a 3.5 character wide time gap. Following the response of the server, client device should wait 3.5 characters long period, before requesting information again.

Data types used in RAPIDUS are as follows.

Table 4-2 int (32 bit) data type

b31 (Bit 31)	-----	b0 (Bit 0)
MSB (Most Significant Bit)	-----	LSB (Least Significant Bit)

**int:**

32-bit integer value. Byte order starts from the lowest byte address as b0, b1, b2 and so on.

**float:**

It is a 32-bit floating-point number in IEEE 754 standard.

**string:**

Character array in ASCII standard. It is only used for RAPIDUS device name and RAPIDUS configuration name variables.

### 4.4 Implemented functions for MODBUS-RTU Protocol

Table 4-3 Implemented functions for MODBUS RTU Protocol

Function Name	Function Code
Read Holding Registers	03H (decimal value 3)
Write Single Register	06H (decimal value 6)
Write Multiple Registers	10H (decimal value 16)
Read file record	14H (decimal value 20)



## 4.5 Data and Setting Parameters for RAPIDUS

### 4.5.1 Measured and Calculated Data



Calculated and measured data are “read-only” values.

Operator/programmer can reach all measured and calculated data via MODBUS RTU protocol. Starting address for measured and calculated data is 0.

#### Example:

Three phase average voltage is read via the 0th and 1th registers (16 bits + 16 bits = 32 bit).

<b>PC (or PLC) Request</b>		<b>RAPIDUS Response</b>	
Slave ID	01h	Slave ID	01h
Function code	03h	Function code	03h
Register address – high	00h	Byte counts	04h
Register address – low	00h	Register value - high (0)	43h
Number of registers– high	00h	Register value - low (0)	5DH
Number of registers – low	02h	Register value - high (1)	36H
CRC high	C4h	Register value - low (1)	E0h
CRC low	0Bh	CRC high	68h
		CRC low	4Dh

The “Byte counts” information of RAPIDUS response is two times “Number of registers” value of “PC request” (1 register = 2 bytes).

Register value high(0) and low(0) together with register value high(1) and low(1) constitute a 32-bit value. This value should be converted (typecasted) to a float value. The float value of the mentioned 32-bit variable is 221.2143555.

### 4.5.1.1 Readable Data for RAPIDUS 231R-E

Table 4-4 Readable Data(RAPIDUS 231R-E)

Address	Parameter	Description	R/W	Unit	Data Type
0	V avg.	Average voltage of three phases	RO	V	32 bit float
2	I tot.	Total current of three phases	RO	A	32 bit float
4	P tot.	Total active power of three phases	RO	W	32 bit float
6	Q tot.	Total reactive power of three phases	RO	VAr	32 bit float
8	S tot.	Total apparent power of three phases	RO	VA	32 bit float
10	CosØ avg.	Average CosØ of three phases	RO	-	32 bit float
12	PF avg.	Average PF of three phases	RO	-	32 bit float
14	VLL12	Voltage V1-2	RO	V	32 bit float
16	VLL23	Voltage V2-3	RO	V	32 bit float
18	VLL31	Voltage V3-1	RO	V	32 bit float
20	VLL avg.	Average of line to line voltage of three phases	RO	V	32 bit float
22	IN	Neutral current	RO	A	32 bit float
24	THDV tot.	Total har. distortion of voltage for three phases	RO	%	32 bit float
26	THDI tot.	Total har. distortion of voltage for three phases	RO	%	32 bit float
<b>PHASE 1</b>					
28	L1 V	Phase1 voltage	RO	V	32 bit float
30	L1 I	Phase1 current	RO	A	32 bit float
32	L1 P	Phase1 active power	RO	W	32 bit float
34	L1 Q	Phase1 reactive power	RO	VAr	32 bit float
36	L1 S	Phase1 apparent power	RO	VA	32 bit float
38	L1 CosØ	Phase1 CosØ	RO	-	32 bit float
40	L1 PF	Phase1 power factor	RO	-	32 bit float
42	L1 F	Phase1 frequency	RO	Hz	32 bit float
44	L1 THDV	Phase1 total har. distortion of voltage	RO	%	32 bit float
46	L1 THDI	Phase1 total har. distortion of current	RO	%	32 bit float
48	L1 V Harmonics 1	Phase1 voltage first harmonic	RO	%	32 bit float
50	L1 V Harmonics 3	Phase1 voltage third harmonic	RO	%	32 bit float
52	L1 V Harmonics 5	Phase1 voltage 5th harmonic	RO	%	32 bit float
54	L1 V Harmonics 7	Phase1 voltage 7th harmonic	RO	%	32 bit float
56	L1 V Harmonics 9	Phase1 voltage 9th harmonic	RO	%	32 bit float
58	L1 V Harmonics 11	Phase1 voltage 11th harmonic	RO	%	32 bit float
60	L1 V Harmonics 13	Phase1 voltage 13th harmonic	RO	%	32 bit float
62	L1 V Harmonics 15	Phase1 voltage 15th harmonic	RO	%	32 bit float
64	L1 V Harmonics 17	Phase1 voltage 17th harmonic	RO	%	32 bit float
66	L1 V Harmonics 19	Phase1 voltage 19th harmonic	RO	%	32 bit float
68	L1 V Harmonics 21	Phase1 voltage 21st harmonic	RO	%	32 bit float
70	L1 V Harmonics 23	Phase1 voltage 23rd harmonic	RO	%	32 bit float
72	L1 V Harmonics 25	Phase1 voltage 25th harmonic	RO	%	32 bit float
74	L1 V Harmonics 27	Phase1 voltage 27th harmonic	RO	%	32 bit float
76	L1 V Harmonics 29	Phase1 voltage 29th harmonic	RO	%	32 bit float
78	L1 V Harmonics 31	Phase1 voltage 31st harmonic	RO	%	32 bit float

Address	Parameter	Description	R/W	Unit	Data Type
80	L1 V Harmonics 33	Phase1 voltage 33rd harmonic	RO	%	32 bit float
82	L1 V Harmonics 35	Phase1 voltage 35th harmonic	RO	%	32 bit float
84	L1 V Harmonics 37	Phase1 voltage 37th harmonic	RO	%	32 bit float
86	L1 V Harmonics 39	Phase1 voltage 39th harmonic	RO	%	32 bit float
88	L1 V Harmonics 41	Phase1 voltage 41st harmonic	RO	%	32 bit float
90	L1 V Harmonics 43	Phase1 voltage 43rd harmonic	RO	%	32 bit float
92	L1 V Harmonics 45	Phase1 voltage 45th harmonic	RO	%	32 bit float
94	L1 V Harmonics 47	Phase1 voltage 47th harmonic	RO	%	32 bit float
96	L1 V Harmonics 49	Phase1 voltage 49th harmonic	RO	%	32 bit float
98	L1 V Harmonics 51	Phase1 voltage 51st harmonic	RO	%	32 bit float
100	L1 I Harmonics 1	Phase1 current first harmonic	RO	%	32 bit float
102	L1 I Harmonics 3	Phase1 current third harmonic	RO	%	32 bit float
104	L1 I Harmonics 5	Phase1 current 5th harmonic	RO	%	32 bit float
106	L1 I Harmonics 7	Phase1 current 7th harmonic	RO	%	32 bit float
108	L1 I Harmonics 9	Phase1 current 9th harmonic	RO	%	32 bit float
110	L1 I Harmonics 11	Phase1 current 11th harmonic	RO	%	32 bit float
112	L1 I Harmonics 13	Phase1 current 13th harmonic	RO	%	32 bit float
114	L1 I Harmonics 15	Phase1 current 15th harmonic	RO	%	32 bit float
116	L1 I Harmonics 17	Phase1 current 17th harmonic	RO	%	32 bit float
118	L1 I Harmonics 19	Phase1 current 19th harmonic	RO	%	32 bit float
120	L1 I Harmonics 21	Phase1 current 21st harmonic	RO	%	32 bit float
122	L1 I Harmonics 23	Phase1 current 23rd harmonic	RO	%	32 bit float
124	L1 I Harmonics 25	Phase1 current 25th harmonic	RO	%	32 bit float
126	L1 I Harmonics 27	Phase1 current 27th harmonic	RO	%	32 bit float
128	L1 I Harmonics 29	Phase1 current 29th harmonic	RO	%	32 bit float
130	L1 I Harmonics 31	Phase1 current 31st harmonic	RO	%	32 bit float
132	L1 I Harmonics 33	Phase1 current 33rd harmonic	RO	%	32 bit float
134	L1 I Harmonics 35	Phase1 current 35th harmonic	RO	%	32 bit float
136	L1 I Harmonics 37	Phase1 current 37th harmonic	RO	%	32 bit float
138	L1 I Harmonics 39	Phase1 current 39th harmonic	RO	%	32 bit float
140	L1 I Harmonics 41	Phase1 current 41st harmonic	RO	%	32 bit float
142	L1 I Harmonics 43	Phase1 current 43rd harmonic	RO	%	32 bit float
144	L1 I Harmonics 45	Phase1 current 45th harmonic	RO	%	32 bit float
146	L1 I Harmonics 47	Phase1 current 47th harmonic	RO	%	32 bit float
148	L1 I Harmonics 49	Phase1 current 49th harmonic	RO	%	32 bit float
150	L1 I Harmonics 51	Phase1 current 51st harmonic	RO	%	32 bit float
<b>PHASE 2</b>					
152	L2 V	Phase2 voltage	RO	V	32 bit float
154	L2 I	Phase2 current	RO	A	32 bit float
156	L2 P	Phase2 active power	RO	W	32 bit float
158	L2 Q	Phase2 reactive power	RO	VAr	32 bit float
160	L2 S	Phase2 apparent power	RO	VA	32 bit float
162	L2 CosØ	Phase2 CosØ	RO	-	32 bit float
164	L2 PF	Phase2 power factor	RO	-	32 bit float



Address	Parameter	Description	R/W	Unit	Data Type
166	L2 F	Phase2 frequency	RO	Hz	32 bit float
168	L2 THDV	Phase2 total har. distortion of voltage	RO	%	32 bit float
170	L2 THDI	Phase2 total har. distortion of current	RO	%	32 bit float
172	L2 V Harmonics 1	Phase2 voltage first harmonic	RO	%	32 bit float
174	L2 V Harmonics 3	Phase2 voltage third harmonic	RO	%	32 bit float
176	L2 V Harmonics 5	Phase2 voltage 5th harmonic	RO	%	32 bit float
178	L2 V Harmonics 7	Phase2 voltage 7th harmonic	RO	%	32 bit float
180	L2 V Harmonics 9	Phase2 voltage 9th harmonic	RO	%	32 bit float
182	L2 V Harmonics 11	Phase2 voltage 11th harmonic	RO	%	32 bit float
184	L2 V Harmonics 13	Phase2 voltage 13th harmonic	RO	%	32 bit float
186	L2 V Harmonics 15	Phase2 voltage 15th harmonic	RO	%	32 bit float
188	L2 V Harmonics 17	Phase2 voltage 17th harmonic	RO	%	32 bit float
190	L2 V Harmonics 19	Phase2 voltage 19th harmonic	RO	%	32 bit float
192	L2 V Harmonics 21	Phase2 voltage 21st harmonic	RO	%	32 bit float
194	L2 V Harmonics 23	Phase2 voltage 23rd harmonic	RO	%	32 bit float
196	L2 V Harmonics 25	Phase2 voltage 25th harmonic	RO	%	32 bit float
198	L2 V Harmonics 27	Phase2 voltage 27th harmonic	RO	%	32 bit float
200	L2 V Harmonics 29	Phase2 voltage 29th harmonic	RO	%	32 bit float
202	L2 V Harmonics 31	Phase2 voltage 31st harmonic	RO	%	32 bit float
204	L2 V Harmonics 33	Phase2 voltage 33rd harmonic	RO	%	32 bit float
206	L2 V Harmonics 35	Phase2 voltage 35th harmonic	RO	%	32 bit float
208	L2 V Harmonics 37	Phase2 voltage 37th harmonic	RO	%	32 bit float
210	L2 V Harmonics 39	Phase2 voltage 39th harmonic	RO	%	32 bit float
212	L2 V Harmonics 41	Phase2 voltage 41st harmonic	RO	%	32 bit float
214	L2 V Harmonics 43	Phase2 voltage 43rd harmonic	RO	%	32 bit float
216	L2 V Harmonics 45	Phase2 voltage 45th harmonic	RO	%	32 bit float
218	L2 V Harmonics 47	Phase2 voltage 47th harmonic	RO	%	32 bit float
220	L2 V Harmonics 49	Phase2 voltage 49th harmonic	RO	%	32 bit float
222	L2 V Harmonics 51	Phase2 voltage 51st harmonic	RO	%	32 bit float
224	L2 I Harmonics 1	Phase2 current first harmonic	RO	%	32 bit float
226	L2 I Harmonics 3	Phase2 current third harmonic	RO	%	32 bit float
228	L2 I Harmonics 5	Phase2 current 5th harmonic	RO	%	32 bit float
230	L2 I Harmonics 7	Phase2 current 7th harmonic	RO	%	32 bit float
232	L2 I Harmonics 9	Phase2 current 9th harmonic	RO	%	32 bit float
234	L2 I Harmonics 11	Phase2 current 11th harmonic	RO	%	32 bit float
236	L2 I Harmonics 13	Phase2 current 13th harmonic	RO	%	32 bit float
238	L2 I Harmonics 15	Phase2 current 15th harmonic	RO	%	32 bit float
240	L2 I Harmonics 17	Phase2 current 17th harmonic	RO	%	32 bit float
242	L2 I Harmonics 19	Phase2 current 19th harmonic	RO	%	32 bit float
244	L2 I Harmonics 21	Phase2 current 21st harmonic	RO	%	32 bit float
246	L2 I Harmonics 23	Phase2 current 23rd harmonic	RO	%	32 bit float
248	L2 I Harmonics 25	Phase2 current 25th harmonic	RO	%	32 bit float
250	L2 I Harmonics 27	Phase2 current 27th harmonic	RO	%	32 bit float
252	L2 I Harmonics 29	Phase2 current 29th harmonic	RO	%	32 bit float

Address	Parameter	Description	R/W	Unit	Data Type
254	L2 I Harmonics 31	Phase2 current 31st harmonic	RO	%	32 bit float
256	L2 I Harmonics 33	Phase2 current 33rd harmonic	RO	%	32 bit float
258	L2 I Harmonics 35	Phase2 current 35th harmonic	RO	%	32 bit float
260	L2 I Harmonics 37	Phase2 current 37th harmonic	RO	%	32 bit float
262	L2 I Harmonics 39	Phase2 current 39th harmonic	RO	%	32 bit float
264	L2 I Harmonics 41	Phase2 current 41st harmonic	RO	%	32 bit float
266	L2 I Harmonics 43	Phase2 current 43rd harmonic	RO	%	32 bit float
268	L2 I Harmonics 45	Phase2 current 45th harmonic	RO	%	32 bit float
270	L2 I Harmonics 47	Phase2 current 47th harmonic	RO	%	32 bit float
272	L2 I Harmonics 49	Phase2 current 49th harmonic	RO	%	32 bit float
274	L2 I Harmonics 51	Phase2 current 51st harmonic	RO	%	32 bit float
<b>PHASE 3</b>					
276	L3 V	Phase3 voltage	RO	V	32 bit float
278	L3 I	Phase3 current	RO	A	32 bit float
280	L3 P	Phase3 active power	RO	W	32 bit float
282	L3 Q	Phase3 reactive power	RO	VAr	32 bit float
284	L3 S	Phase3 apparent power	RO	VA	32 bit float
286	L3 CosØ	Phase3 CosØ	RO	-	32 bit float
288	L3 PF	Phase3 power factor	RO	-	32 bit float
290	L3 F	Phase3 frequency	RO	Hz	32 bit float
292	L3 THDV	Phase3 total har. distortion of voltage	RO	%	32 bit float
294	L3 THDI	Phase3 total har. distortion of current	RO	%	32 bit float
296	L3 V Harmonics 1	Phase3 voltage first harmonic	RO	%	32 bit float
298	L3 V Harmonics 3	Phase3 voltage third harmonic	RO	%	32 bit float
300	L3 V Harmonics 5	Phase3 voltage 5th harmonic	RO	%	32 bit float
302	L3 V Harmonics 7	Phase3 voltage 7th harmonic	RO	%	32 bit float
304	L3 V Harmonics 9	Phase3 voltage 9th harmonic	RO	%	32 bit float
306	L3 V Harmonics 11	Phase3 voltage 11th harmonic	RO	%	32 bit float
308	L3 V Harmonics 13	Phase3 voltage 13th harmonic	RO	%	32 bit float
310	L3 V Harmonics 15	Phase3 voltage 15th harmonic	RO	%	32 bit float
312	L3 V Harmonics 17	Phase3 voltage 17th harmonic	RO	%	32 bit float
314	L3 V Harmonics 19	Phase3 voltage 19th harmonic	RO	%	32 bit float
316	L3 V Harmonics 21	Phase3 voltage 21st harmonic	RO	%	32 bit float
318	L3 V Harmonics 23	Phase3 voltage 23rd harmonic	RO	%	32 bit float
320	L3 V Harmonics 25	Phase3 voltage 25th harmonic	RO	%	32 bit float
322	L3 V Harmonics 27	Phase3 voltage 27th harmonic	RO	%	32 bit float
324	L3 V Harmonics 29	Phase3 voltage 29th harmonic	RO	%	32 bit float
326	L3 V Harmonics 31	Phase3 voltage 31st harmonic	RO	%	32 bit float
328	L3 V Harmonics 33	Phase3 voltage 33rd harmonic	RO	%	32 bit float
330	L3 V Harmonics 35	Phase3 voltage 35th harmonic	RO	%	32 bit float
332	L3 V Harmonics 37	Phase3 voltage 37th harmonic	RO	%	32 bit float
334	L3 V Harmonics 39	Phase3 voltage 39th harmonic	RO	%	32 bit float
336	L3 V Harmonics 41	Phase3 voltage 41st harmonic	RO	%	32 bit float
338	L3 V Harmonics 43	Phase3 voltage 43rd harmonic	RO	%	32 bit float

Address	Parameter	Description	R/W	Unit	Data Type
340	L3 V Harmonics 45	Phase3 voltage 45th harmonic	RO	%	32 bit float
342	L3 V Harmonics 47	Phase3 voltage 47th harmonic	RO	%	32 bit float
344	L3 V Harmonics 49	Phase3 voltage 49th harmonic	RO	%	32 bit float
346	L3 V Harmonics 51	Phase3 voltage 51st harmonic	RO	%	32 bit float
348	L3 I Harmonics 1	Phase3 current first harmonic	RO	%	32 bit float
350	L3 I Harmonics 3	Phase3 current third harmonic	RO	%	32 bit float
352	L3 I Harmonics 5	Phase3 current 5th harmonic	RO	%	32 bit float
354	L3 I Harmonics 7	Phase3 current 7th harmonic	RO	%	32 bit float
356	L3 I Harmonics 9	Phase3 current 9th harmonic	RO	%	32 bit float
358	L3 I Harmonics 11	Phase3 current 11th harmonic	RO	%	32 bit float
360	L3 I Harmonics 13	Phase3 current 13th harmonic	RO	%	32 bit float
362	L3 I Harmonics 15	Phase3 current 15th harmonic	RO	%	32 bit float
364	L3 I Harmonics 17	Phase3 current 17th harmonic	RO	%	32 bit float
366	L3 I Harmonics 19	Phase3 current 19th harmonic	RO	%	32 bit float
368	L3 I Harmonics 21	Phase3 current 21st harmonic	RO	%	32 bit float
370	L3 I Harmonics 23	Phase3 current 23rd harmonic	RO	%	32 bit float
372	L3 I Harmonics 25	Phase3 current 25th harmonic	RO	%	32 bit float
374	L3 I Harmonics 27	Phase3 current 27th harmonic	RO	%	32 bit float
376	L3 I Harmonics 29	Phase3 current 29th harmonic	RO	%	32 bit float
378	L3 I Harmonics 31	Phase3 current 31st harmonic	RO	%	32 bit float
380	L3 I Harmonics 33	Phase3 current 33rd harmonic	RO	%	32 bit float
382	L3 I Harmonics 35	Phase3 current 35th harmonic	RO	%	32 bit float
384	L3 I Harmonics 37	Phase3 current 37th harmonic	RO	%	32 bit float
386	L3 I Harmonics 39	Phase3 current 39th harmonic	RO	%	32 bit float
388	L3 I Harmonics 41	Phase3 current 41st harmonic	RO	%	32 bit float
390	L3 I Harmonics 43	Phase3 current 43rd harmonic	RO	%	32 bit float
392	L3 I Harmonics 45	Phase3 current 45th harmonic	RO	%	32 bit float
394	L3 I Harmonics 47	Phase3 current 47th harmonic	RO	%	32 bit float
396	L3 I Harmonics 49	Phase3 current 49th harmonic	RO	%	32 bit float
398	L3 I Harmonics 51	Phase3 current 51st harmonic	RO	%	32 bit float
<b>ALARM FLAGS</b>					
400	Alarms 1	Alarm flag 1 (first 32 bit)	RO	-	32 bit int.
402	Alarms 2	Alarm flag 2 (second 32 bit)	RO	-	32 bit int.
<b>STEP VARIABLES</b>					
404	Active step	Active step flags	RO	-	32 bit int.
406	Available step	Available step flags	RO	-	32 bit int.
408	Fixed step	Fixed step flags	RO	-	32 bit int.
410	S1 switching count	Step 1 switching count	RO	-	32 bit int.
412	S2 switching count	Step 2 switching count	RO	-	32 bit int.
414	S3 switching count	Step 3 switching count	RO	-	32 bit int.
416	S4 switching count	Step 4 switching count	RO	-	32 bit int.
418	S5 switching count	Step 5 switching count	RO	-	32 bit int.
420	S6 switching count	Step 6 switching count	RO	-	32 bit int.
422	S7 switching count	Step 7 switching count	RO	-	32 bit int.

Address	Parameter	Description	R/W	Unit	Data Type
424	S8 switching count	Step 8 switching count	RO	-	32 bit int.
426	S9 switching count	Step 9 switching count	RO	-	32 bit int.
428	S10 switching count	Step 10 switching count	RO	-	32 bit int.
430	S11 switching count	Step 11 switching count	RO	-	32 bit int.
432	S12 switching count	Step 12 switching count	RO	-	32 bit int.
434	S1 operation time	Step 1 operation time	RO	min.	32 bit int.
436	S2 operation time	Step 2 operation time	RO	min.	32 bit int.
438	S3 operation time	Step 3 operation time	RO	min.	32 bit int.
440	S4 operation time	Step 4 operation time	RO	min.	32 bit int.
442	S5 operation time	Step 5 operation time	RO	min.	32 bit int.
444	S6 operation time	Step 6 operation time	RO	min.	32 bit int.
446	S7 operation time	Step 7 operation time	RO	min.	32 bit int.
448	S8 operation time	Step 8 operation time	RO	min.	32 bit int.
450	S9 operation time	Step 9 operation time	RO	min.	32 bit int.
452	S10 operation time	Step 10 operation time	RO	min.	32 bit int.
454	S11 operation time	Step 11 operation time	RO	min.	32 bit int.
456	S12 operation time	Step 12 operation time	RO	min.	32 bit int.
<b>ENERGY METERS (32 bit)</b>					
458	T1 Imp. Act. Index	Tariff 1 Import Active Index	RO	kWh	32 bit float
460	T1 Imp. Act. Curr. Hour	Tariff 1 Import Active Current Hour	RO	kWh	32 bit float
462	T1 Imp. Act. Prev. Hour	Tariff 1 Import Active Previous Hour	RO	kWh	32 bit float
464	T1 Imp. Act. Curr. Day	Tariff 1 Import. Active Current Day	RO	kWh	32 bit float
466	T1 Imp. Act. Prev. Day	Tariff 1 Import Active Previous Day	RO	kWh	32 bit float
468	T1 Imp. Act. Curr. Month	Tariff 1 Import Active Current Month	RO	kWh	32 bit float
470	T1 Imp. Act. Prev. Month	Tariff 1 Import Previous Month	RO	kWh	32 bit float
472	T1 Exp. Act. Index	Tariff 1 Export Active Index	RO	kWh	32 bit float
474	T1 Exp. Act. Curr. Hour	Tariff 1 Export Active Current Hour	RO	kWh	32 bit float
476	T1 Exp. Act. Prev. Hour	Tariff 1 Export Active Previous Hour	RO	kWh	32 bit float
478	T1 Exp. Act. Curr. Day	Tariff 1 Export Active Current Day	RO	kWh	32 bit float
480	T1 Exp. Act. Prev. Day	Tariff 1 Export Active Previous Day	RO	kWh	32 bit float
482	T1 Exp. Act. Curr. Month	Tariff 1 Export Active Current Month	RO	kWh	32 bit float
484	T1 Exp. Act. Prev. Month	Tariff 1 Export Active Previous Month	RO	kWh	32 bit float
486	T1 Ind. React. Index	Tariff 1 Inductive Reactive Index	RO	kVArh	32 bit float
488	T1 Ind. React. Curr. Hour	Tariff 1 Inductive Reactive Current Hour	RO	kVArh	32 bit float
490	T1 Ind. React. Prev. Hour	Tariff 1 Inductive Reactive Previous Hour	RO	kVArh	32 bit float
492	T1 Ind. React. Curr. Day	Tariff 1 Inductive Reactive Current Day	RO	kVArh	32 bit float
494	T1 Ind. React. Prev. Day	Tariff 1 Inductive Reactive Previous Day	RO	kVArh	32 bit float
496	T1 Ind. React. Curr. Month	Tariff 1 Inductive Reactive Current Month	RO	kVArh	32 bit float
498	T1 Ind. React. Prev. Month	Tariff 1 Inductive Reactive Previous Month	RO	kVArh	32 bit float
500	T1 Cap. React. Index	Tariff 1 Capacitive Reactive Index	RO	kVArh	32 bit float
502	T1 Cap. React. Curr. Hour	Tariff 1 Capacitive Reactive Current Hour	RO	kVArh	32 bit float
504	T1 Cap. React. Prev. Hour	Tariff 1 Capacitive Reactive Previous Hour	RO	kVArh	32 bit float
506	T1 Cap. React. Curr. Day	Tariff 1 Capacitive Reactive Current Day	RO	kVArh	32 bit float
508	T1 Cap. React. Prev. Day	Tariff 1 Capacitive Reactive Previous Day	RO	kVArh	32 bit float

Address	Parameter	Description	R/W	Unit	Data Type
510	T1 Cap. React. Curr. Month	Tariff 1 Capacitive Reactive Current Month	RO	kVArh	32 bit float
512	T1 Cap. React. Prev. Month	Tariff 1 Capacitive Reactive Previous Month	RO	kVArh	32 bit float
<b>DEMAND</b>					
514	Curr. Month P tot.	Current Month Total Active Power	RO	W	32 bit float
516	Curr. Month P tot. time	Current Month Total Active Power Timestamp	RO	-	32 bit unix time
518	Curr. Month I tot.	Current Month Total Current	RO	A	32 bit float
520	Curr. Month I tot. time	Current Month Total Current Timestamp	RO	-	32 bit unix time
522	Curr. Month Q tot.	Current Month Total Reactive Power	RO	VAr	32 bit float
524	Curr. Month Q tot. time	Current Month Total Reactive Power Timestamp	RO	-	32 bit unix time
526	Curr. Month S tot.	Current Month Total Apparent Power	RO	VA	32 bit float
528	Curr. Month S tot. time	Current Month Total Apparent Power Timestamp	RO	-	32 bit unix time
530	Curr. Month L1 P	Current Month Phase 1 Active Power	RO	W	32 bit float
532	Curr. Month L1 P time	Current Month Phase 1 Active Power Timestamp	RO	-	32 bit unix time
534	Curr. Month L1 I	Current Month Phase 1 Current	RO	A	32 bit float
536	Curr. Month L1 I time	Current Month Phase 1 Current Timestamp	RO	-	32 bit unix time
538	Curr. Month L1 Q	Current Month Phase 1 Reactive Power	RO	VAr	32 bit float
540	Curr. Month L1 Q time	Current Month Phase 1 Reactive Power Timestamp	RO	-	32 bit unix time
542	Curr. Month L1 S	Current Month Phase 1 Apparent Power	RO	VA	32 bit float
544	Curr. Month L1 S time	Current Month Phase 1 Apparent Power Timestamp	RO	-	32 bit unix time
546	Curr. Month L2 P	Current Month Phase 2 Active Power	RO	W	32 bit float
548	Curr. Month L2 P time	Current Month Phase 2 Active Power Timestamp	RO	-	32 bit unix time
550	Curr. Month L2 I	Current Month Phase 2 Current	RO	A	32 bit float
552	Curr. Month L2 I time	Current Month Phase 2 Current Timestamp	RO	-	32 bit unix time
554	Curr. Month L2 Q	Current Month Phase 2 Reactive Power	RO	VAr	32 bit float
556	Curr. Month L2 Q time	Current Month Phase 2 Reactive Power Timestamp	RO	-	32 bit unix time
558	Curr. Month L2 S	Current Month Phase 2 Apparent Power	RO	VA	32 bit float
560	Curr. Month L2 S time	Current Month Phase 2 Apparent Power Timestamp	RO	-	32 bit unix time
562	Curr. Month L3 P	Current Month Phase 3 Active Power	RO	W	32 bit float
564	Curr. Month L3 P time	Current Month Phase 3 Active Power Timestamp	RO	-	32 bit unix time
566	Curr. Month L3 I	Current Month Phase 3 Current	RO	A	32 bit float
568	Curr. Month L3 I time	Current Month Phase 3 Current Timestamp	RO	-	32 bit unix time
570	Curr. Month L3 Q	Current Month Phase 3 Reactive Power	RO	VAr	32 bit float
572	Curr. Month L3 Q time	Current Month Phase 3 Reactive Power Timestamp	RO	-	32 bit unix time
574	Curr. Month L3 S	Current Month Phase 3 Apparent Power	RO	VA	32 bit float
576	Curr. Month L3 S time	Current Month Phase 3 Apparent Power Timestamp	RO	-	32 bit unix time

Address	Parameter	Description	R/W	Unit	Data Type
<b>OTHER</b>					
578	Temp.	Temperature Value	RO	°C	32 bit float
580	Battery Voltage	-	RO	V	32 bit float
582	Time	System Date and Time	R/W	-	32 bit unix time
<b>ALARM STATUSES</b>					
584	1 - Alarm Timestamp	1 - Alarm time	RO	-	32 bit unix time
586	1 - Alarm ID	1 - Alarm ID	RO	-	32 bit int.
588	1 - Alarm Status	1 - Alarm ON /Alarm OFF status	RO	-	32 bit int.
590	1 - Alarm Value	1 - Value of related alarm parameter	RO	-	32 bit float
592	2 - Alarm Timestamp	2 - Alarm time	RO	-	32 bit unix time
594	2 - Alarm ID	2 - Alarm ID	RO	-	32 bit int.
596	2 - Alarm Status	2 - Alarm ON /Alarm OFF status	RO	-	32 bit int.
598	2 - Alarm Value	2 - Value of related alarm parameter	RO	-	32 bit float
600	3 - Alarm Timestamp	3 - Alarm time	RO	-	32 bit unix time
602	3 - Alarm ID	3 - Alarm ID	RO	-	32 bit int.
604	3 - Alarm Status	3 - Alarm ON /Alarm OFF status	RO	-	32 bit int.
606	3 - Alarm Value	3 - Value of related alarm parameter	RO	-	32 bit float
608	4 - Alarm Timestamp	4 - Alarm time	RO	-	32 bit unix time
610	4 - Alarm ID	4 - Alarm ID	RO	-	32 bit int.
612	4 - Alarm Status	4 - Alarm ON /Alarm OFF status	RO	-	32 bit int.
614	4 - Alarm Value	4 - Value of related alarm parameter	RO	-	32 bit float
616	5 - Alarm Timestamp	5 - Alarm time	RO	-	32 bit unix time
618	5 - Alarm ID	5 - Alarm ID	RO	-	32 bit int.
620	5 - Alarm Status	5 - Alarm ON /Alarm OFF status	RO	-	32 bit int.
622	5 - Alarm Value	5 - Value of related alarm parameter	RO	-	32 bit float
624	6 - Alarm Timestamp	6 - Alarm time	RO	-	32 bit unix time
626	6 - Alarm ID	6 - Alarm ID	RO	-	32 bit int.
628	6 - Alarm Status	6 - Alarm ON /Alarm OFF status	RO	-	32 bit int.
630	6 - Alarm Value	6 - Value of related alarm parameter	RO	-	32 bit float
632	7 - Alarm Timestamp	7 - Alarm time	RO	-	32 bit unix time
634	7 - Alarm ID	7 - Alarm ID	RO	-	32 bit int.
636	7 - Alarm Status	7 - Alarm ON /Alarm OFF status	RO	-	32 bit int.
638	7 - Alarm Value	7 - Value of related alarm parameter	RO	-	32 bit float
640	8 - Alarm Timestamp	8 - Alarm time	RO	-	32 bit unix time
642	8 - Alarm ID	8 - Alarm ID	RO	-	32 bit int.
644	8 - Alarm Status	8 - Alarm ON /Alarm OFF status	RO	-	32 bit int.
646	8 - Alarm Value	8 - Value of related alarm parameter	RO	-	32 bit float
648	9 - Alarm Timestamp	9 - Alarm time	RO	-	32 bit unix time
650	9 - Alarm ID	9 - Alarm ID	RO	-	32 bit int.
652	9 - Alarm Status	9 - Alarm ON /Alarm OFF status	RO	-	32 bit int.
654	9 - Alarm Value	9 - Value of related alarm parameter	RO	-	32 bit float
656	10 - Alarm Timestamp	10 - Alarm time	RO	-	32 bit unix time
658	10 - Alarm ID	10 - Alarm ID	RO	-	32 bit int.
660	10 - Alarm Status	10 - Alarm ON /Alarm OFF status	RO	-	32 bit int.

Address	Parameter	Description	R/W	Unit	Data Type
662	10 - Alarm Value	10 - Value of related alarm parameter	RO	-	32 bit float
664	11 - Alarm Timestamp	11 - Alarm time	RO	-	32 bit unix time
666	11 - Alarm ID	11 - Alarm ID	RO	-	32 bit int.
668	11 - Alarm Status	11 - Alarm ON /Alarm OFF status	RO	-	32 bit int.
670	11 - Alarm Value	11 - Value of related alarm parameter	RO	-	32 bit float
672	12 - Alarm Timestamp	12 - Alarm time	RO	-	32 bit unix time
674	12 - Alarm ID	12 - Alarm ID	RO	-	32 bit int.
676	12 - Alarm Status	12 - Alarm ON /Alarm OFF status	RO	-	32 bit int.
678	12 - Alarm Value	12 - Value of related alarm parameter	RO	-	32 bit float
680	13 - Alarm Timestamp	13 - Alarm time	RO	-	32 bit unix time
682	13 - Alarm ID	13 - Alarm ID	RO	-	32 bit int.
684	13 - Alarm Status	13 - Alarm ON /Alarm OFF status	RO	-	32 bit int.
686	13 - Alarm Value	13 - Value of related alarm parameter	RO	-	32 bit float
688	14 - Alarm Timestamp	14 - Alarm time	RO	-	32 bit unix time
690	14 - Alarm ID	14 - Alarm ID	RO	-	32 bit int.
692	14 - Alarm Status	14 - Alarm ON /Alarm OFF status	RO	-	32 bit int.
694	14 - Alarm Value	14 - Value of related alarm parameter	RO	-	32 bit float
696	15 - Alarm Timestamp	15 - Alarm zaman değeri	RO	-	32 bit unix time
698	15 - Alarm ID	15 - Alarm ID	RO	-	32 bit int.
700	15 - Alarm Status	15 - Alarm ON /Alarm OFF status	RO	-	32 bit int.
702	15 - Alarm Value	15 - Value of related alarm parameter	RO	-	32 bit float
704	16 - Alarm Timestamp	16 - Alarm time	RO	-	32 bit unix time
706	16 - Alarm ID	16 - Alarm ID	RO	-	32 bit int.
708	16 - Alarm Status	16 - Alarm ON /Alarm OFF status	RO	-	32 bit int.
710	16 - Alarm Value	16 - Value of related alarm parameter	RO	-	32 bit float
712	17 - Alarm Timestamp	17 - Alarm time	RO	-	32 bit unix time
714	17 - Alarm ID	17 - Alarm ID	RO	-	32 bit int.
716	17 - Alarm Status	17 - Alarm ON /Alarm OFF status	RO	-	32 bit int.
718	17 - Alarm Value	17 - Value of related alarm parameter	RO	-	32 bit float
720	18 - Alarm Timestamp	18 - Alarm time	RO	-	32 bit unix time
722	18 - Alarm ID	18 - Alarm ID	RO	-	32 bit int.
724	18 - Alarm Status	18 - Alarm ON /Alarm OFF status	RO	-	32 bit int.
726	18 - Alarm Value	18 - Value of related alarm parameter	RO	-	32 bit float
728	19 - Alarm Timestamp	19 - Alarm time	RO	-	32 bit unix time
730	19 - Alarm ID	19 - Alarm ID	RO	-	32 bit int.
732	19 - Alarm Status	19 - Alarm ON /Alarm OFF status	RO	-	32 bit int.
734	19 - Alarm Value	19 - Value of related alarm parameter	RO	-	32 bit float
736	20 - Alarm Timestamp	20 - Alarm time	RO	-	32 bit unix time
738	20 - Alarm ID	20 - Alarm ID	RO	-	32 bit int.
740	20 - Alarm Status	20 - Alarm ON /Alarm OFF status	RO	-	32 bit int.
742	20 - Alarm Value	20 - Value of related alarm parameter	RO	-	32 bit float
744	21 - Alarm Timestamp	21 - Alarm time	RO	-	32 bit unix time
746	21 - Alarm ID	21 - Alarm ID	RO	-	32 bit int.
748	21 - Alarm Status	21 - Alarm ON /Alarm OFF status	RO	-	32 bit int.

Address	Parameter	Description	R/W	Unit	Data Type
750	21 - Alarm Value	21 - Value of related alarm parameter	RO	-	32 bit float
752	22 - Alarm Timestamp	22 - Alarm time	RO	-	32 bit unix time
754	22 - Alarm ID	22 - Alarm ID	RO	-	32 bit int.
756	22 - Alarm Status	22 - Alarm ON /Alarm OFF status	RO	-	32 bit int.
758	22 - Alarm Value	22 - Value of related alarm parameter	RO	-	32 bit float
760	23 - Alarm Timestamp	23 - Alarm time	RO	-	32 bit unix time
762	23 - Alarm ID	23 - Alarm ID	RO	-	32 bit int.
764	23 - Alarm Status	23 - Alarm ON /Alarm OFF status	RO	-	32 bit int.
766	23 - Alarm Value	23 - Value of related alarm parameter	RO	-	32 bit float
768	24 - Alarm Timestamp	24 - Alarm time	RO	-	32 bit unix time
770	24 - Alarm ID	24 - Alarm ID	RO	-	32 bit int.
772	24 - Alarm Status	24 - Alarm ON /Alarm OFF status	RO	-	32 bit int.
774	24 - Alarm Value	24 - Value of related alarm parameter	RO	-	32 bit float
776	25 - Alarm Timestamp	25 - Alarm time	RO	-	32 bit unix time
778	25 - Alarm ID	25 - Alarm ID	RO	-	32 bit int.
780	25 - Alarm Status	25 - Alarm ON /Alarm OFF status	RO	-	32 bit int.
782	25 - Alarm Value	25 - Value of related alarm parameter	RO	-	32 bit float
784	26 - Alarm Timestamp	26 - Alarm time	RO	-	32 bit unix time
786	26 - Alarm ID	26 - Alarm ID	RO	-	32 bit int.
788	26 - Alarm Status	26 - Alarm ON /Alarm OFF status	RO	-	32 bit int.
790	26 - Alarm Value	26 - Value of related alarm parameter	RO	-	32 bit float
792	27 - Alarm Timestamp	27 - Alarm time	RO	-	32 bit unix time
794	27 - Alarm ID	27 - Alarm ID	RO	-	32 bit int.
796	27 - Alarm Status	27 - Alarm ON /Alarm OFF status	RO	-	32 bit int.
798	27 - Alarm Value	27 - Value of related alarm parameter	RO	-	32 bit float
800	28 - Alarm Timestamp	28 - Alarm time	RO	-	32 bit unix time
802	28 - Alarm ID	28 - Alarm ID	RO	-	32 bit int.
804	28 - Alarm Status	28 - Alarm ON /Alarm OFF status	RO	-	32 bit int.
806	28 - Alarm Value	28 - Value of related alarm parameter	RO	-	32 bit float
808	29 - Alarm Timestamp	29 - Alarm time	RO	-	32 bit unix time
810	29 - Alarm ID	29 - Alarm ID	RO	-	32 bit int.
812	29 - Alarm Status	29 - Alarm ON /Alarm OFF status	RO	-	32 bit int.
814	29 - Alarm Value	29 - Value of related alarm parameter	RO	-	32 bit float
816	30 - Alarm Timestamp	30 - Alarm time	RO	-	32 bit unix time
818	30 - Alarm ID	30 - Alarm ID	RO	-	32 bit int.
820	30 - Alarm Status	30 - Alarm ON /Alarm OFF status	RO	-	32 bit int.
822	30 - Alarm Value	30 - Value of related alarm parameter	RO	-	32 bit float
824	31 - Alarm Timestamp	31 - Alarm time	RO	-	32 bit unix time
826	31 - Alarm ID	31 - Alarm ID	RO	-	32 bit int.
828	31 - Alarm Status	31 - Alarm ON /Alarm OFF status	RO	-	32 bit int.
830	31 - Alarm Value	31 - Value of related alarm parameter	RO	-	32 bit float
832	31 - Alarm Timestamp	32 - Alarm time	RO	-	32 bit unix time
834	32 - Alarm ID	32 - Alarm ID	RO	-	32 bit int.
836	32 - Alarm Status	32 - Alarm ON /Alarm OFF status	RO	-	32 bit int.



Address	Parameter	Description	R/W	Unit	Data Type
838	32 - Alarm Value	32 - Value of related alarm parameter	RO	-	32 bit float
840	33 - Alarm Timestamp	33 - Alarm time	RO	-	32 bit unix time
842	33 - Alarm ID	33 - Alarm ID	RO	-	32 bit int.
844	33 - Alarm Status	33 - Alarm ON /Alarm OFF status	RO	-	32 bit int.
846	33 - Alarm Value	33 - Value of related alarm parameter	RO	-	32 bit float
848	34 - Alarm Timestamp	34 - Alarm time	RO	-	32 bit unix time
850	34 - Alarm ID	34 - Alarm ID	RO	-	32 bit int.
852	34 - Alarm Status	34 - Alarm ON /Alarm OFF status	RO	-	32 bit int.
854	34 - Alarm Value	34 - Value of related alarm parameter	RO	-	32 bit float
856	35 - Alarm Timestamp	35 - Alarm time	RO	-	32 bit unix time
858	35 - Alarm ID	35 - Alarm ID	RO	-	32 bit int.
860	35 - Alarm Status	35 - Alarm ON /Alarm OFF status	RO	-	32 bit int.
862	35 - Alarm Value	35 - Value of related alarm parameter	RO	-	32 bit float
864	36 - Alarm Timestamp	36 - Alarm time	RO	-	32 bit unix time
866	36 - Alarm ID	36 - Alarm ID	RO	-	32 bit int.
868	36 - Alarm Status	36 - Alarm ON /Alarm OFF status	RO	-	32 bit int.
870	36 - Alarm Value	36 - Value of related alarm parameter	RO	-	32 bit float
872	37 - Alarm Timestamp	37 - Alarm time	RO	-	32 bit unix time
874	37 - Alarm ID	37 - Alarm ID	RO	-	32 bit int.
876	37 - Alarm Status	37 - Alarm ON /Alarm OFF status	RO	-	32 bit int.
878	37 - Alarm Value	37 - Value of related alarm parameter	RO	-	32 bit float
880	38 - Alarm Timestamp	38 - Alarm time	RO	-	32 bit unix time
882	38 - Alarm ID	38 - Alarm ID	RO	-	32 bit int.
884	38 - Alarm Status	38 - Alarm ON /Alarm OFF status	RO	-	32 bit int.
886	38 - Alarm Value	38 - Value of related alarm parameter	RO	-	32 bit float
888	39 - Alarm Timestamp	39 - Alarm time	RO	-	32 bit unix time
890	39 - Alarm ID	39 - Alarm ID	RO	-	32 bit int.
892	39 - Alarm Status	39 - Alarm ON /Alarm OFF status	RO	-	32 bit int.
894	39 - Alarm Value	39 - Value of related alarm parameter	RO	-	32 bit float
896	40 - Alarm Timestamp	40 - Alarm time	RO	-	32 bit unix time
898	40 - Alarm ID	40 - Alarm ID	RO	-	32 bit int.
900	40 - Alarm Status	40 - Alarm ON /Alarm OFF status	RO	-	32 bit int.
902	40 - Alarm Value	40 - Value of related alarm parameter	RO	-	32 bit float
904	41 - Alarm Timestamp	41 - Alarm time	RO	-	32 bit unix time
906	41 - Alarm ID	41 - Alarm ID	RO	-	32 bit int.
908	41 - Alarm Status	41 - Alarm ON /Alarm OFF status	RO	-	32 bit int.
910	41 - Alarm Value	41 - Value of related alarm parameter	RO	-	32 bit float
912	42 - Alarm Timestamp	42 - Alarm time	RO	-	32 bit unix time
914	42 - Alarm ID	42 - Alarm ID	RO	-	32 bit int.
916	42 - Alarm Status	42 - Alarm ON /Alarm OFF status	RO	-	32 bit int.
918	42 - Alarm Value	42 - Value of related alarm parameter	RO	-	32 bit float
920	43 - Alarm Timestamp	43 - Alarm time	RO	-	32 bit unix time
922	43 - Alarm ID	43 - Alarm ID	RO	-	32 bit int.
924	43 - Alarm Status	43 - Alarm ON /Alarm OFF status	RO	-	32 bit int.

Address	Parameter	Description	R/W	Unit	Data Type
926	43 - Alarm Value	43 - Value of related alarm parameter	RO	-	32 bit float
928	44 - Alarm Timestamp	44 - Alarm time	RO	-	32 bit unix time
930	44 - Alarm ID	44 - Alarm ID	RO	-	32 bit int.
932	44 - Alarm Status	44 - Alarm ON /Alarm OFF status	RO	-	32 bit int.
934	44 - Alarm Value	44 - Value of related alarm parameter	RO	-	32 bit float
936	45 - Alarm Timestamp	45 - Alarm time	RO	-	32 bit unix time
938	45 - Alarm ID	45 - Alarm ID	RO	-	32 bit int.
940	45 - Alarm Status	45 - Alarm ON /Alarm OFF status	RO	-	32 bit int.
942	45 - Alarm Value	45 - Value of related alarm parameter	RO	-	32 bit float
944	46 - Alarm Timestamp	46 - Alarm time	RO	-	32 bit unix time
946	46 - Alarm ID	46 - Alarm ID	RO	-	32 bit int.
948	46 - Alarm Status	46 - Alarm ON /Alarm OFF status	RO	-	32 bit int.
950	46 - Alarm Value	46 - Value of related alarm parameter	RO	-	32 bit float
952	47 - Alarm Timestamp	47 - Alarm time	RO	-	32 bit unix time
954	47 - Alarm ID	47 - Alarm ID	RO	-	32 bit int.
956	47 - Alarm Status	47 - Alarm ON /Alarm OFF status	RO	-	32 bit int.
958	47 - Alarm Value	47 - Value of related alarm parameter	RO	-	32 bit float
960	48 - Alarm Timestamp	48 - Alarm time	RO	-	32 bit unix time
962	48 - Alarm ID	48 - Alarm ID	RO	-	32 bit int.
964	48 - Alarm Status	48 - Alarm ON /Alarm OFF status	RO	-	32 bit int.
966	48 - Alarm Value	48 - Value of related alarm parameter	RO	-	32 bit float
968	49 - Alarm Timestamp	49 - Alarm time	RO	-	32 bit unix time
970	49 - Alarm ID	49 - Alarm ID	RO	-	32 bit int.
972	49 - Alarm Status	49 - Alarm ON /Alarm OFF status	RO	-	32 bit int.
974	49 - Alarm Value	49 - Value of related alarm parameter	RO	-	32 bit float
976	50 - Alarm Timestamp	50 - Alarm time	RO	-	32 bit unix time
978	50 - Alarm ID	50 - Alarm ID	RO	-	32 bit int.
980	50 - Alarm Status	50 - Alarm ON /Alarm OFF status	RO	-	32 bit int.
982	50 - Alarm Value	50 - Value of related alarm parameter	RO	-	32 bit float
<b>LAST SAVED FILE NUMBERS</b>					
984	Hourly Archival File Nr.	Latest recorded hourly archival file number	RO	-	32 bit int.
986	Daily Archival File Nr.	Latest recorded daily archival file number	RO	-	32 bit int.
988	Monthly Archival File Nr.	Latest recorded monthly archival file number	RO	-	32 bit int.
<b>ESTIMATED STEP POWERS (DCM Values)</b>					
990	Estimated S1 Power	Estimated Step 1 Power	RO	kVAr	32 bit float
992	Estimated S2 Power	Estimated Step 2 Power	RO	kVAr	32 bit float
994	Estimated S3 Power	Estimated Step 3 Power	RO	kVAr	32 bit float
996	Estimated S4 Power	Estimated Step 4 Power	RO	kVAr	32 bit float
998	Estimated S5 Power	Estimated Step 5 Power	RO	kVAr	32 bit float
1000	Estimated S6 Power	Estimated Step 6 Power	RO	kVAr	32 bit float
1002	Estimated S7 Power	Estimated Step 7 Power	RO	kVAr	32 bit float
1004	Estimated S8 Power	Estimated Step 8 Power	RO	kVAr	32 bit float
1006	Estimated S9 Power	Estimated Step 9 Power	RO	kVAr	32 bit float
1008	Estimated S10 Power	Estimated Step 10 Power	RO	kVAr	32 bit float
1010	Estimated S11 Power	Estimated Step 11 Power	RO	kVAr	32 bit float
1012	Estimated S12 Power	Estimated Step 12 Power	RO	kVAr	32 bit float

Address	Parameter	Description	R/W	Unit	Data Type
<b>GENERATOR INPUT STATUS</b>					
1014	Gen Input	Jenerator Active/Passive Status	RO	-	32 bit float
<b>ENERGY METERS (64 bit)</b>					
1016	T1 Imp. Active Index	Tariff 1 Import Active Index	RO	kWh	64 bit double
1020	T1 Exp. Active Index	Tariff 1 ExportActive Index	RO	kWh	64 bit double
1024	T1 Ind. Reactive Index	Tariff 1 Inductive Reactive Index	RO	kVArh	64 bit double
1028	T1 Cap. Reactive Index	Tariff 1 Capacitive Reactive Index	RO	kVArh	64 bit double

**Unix time:** Unix time is the number of seconds elapsed since midnight (00:00) Coordinated Universal Time (UTC) of January 1, 1970, not counting leaps seconds.

**NOTE:** Tariff Meters' Index Values can be read in 32 bit and/or 64bit floating point format. Mathematically, 64bit floating point representation is more accurate than 32 bit floating point format.

**e.g.**

When it is required to read "Tariff 1 Import Active Index" value, it can be received either 32 bit floating point format (modbus adr. 458) or in 64 bit floating point format (modbus adr.

1016).

If related index value is wanted to read more sensitive, 64bit versions must be selected.

#### 4.5.1.1.1 Alarm Flags(RAPIDUS 231R-E)

Each bit of an alarm flag variable corresponds to 'one' alarm flag.

If any bit's value is "1", then there is alarm for that bit. On the contrary, a bit value of "1" means that there is NO alarm for that bit.

The contents of alarm flag variables are listed below.

#### Alarms 1

<b>b7</b> THDV1	<b>b6</b> I3	<b>b5</b> I2	<b>b4</b> I1	<b>b3</b> V3	<b>b2</b> V2	<b>b1</b> V1	<b>b0</b> Sic.
<b>b15</b> VLL31	<b>b14</b> VLL23	<b>b13</b> VLL12	<b>b12</b> V3 Harmonics	<b>b11</b> V2 Harmonics	<b>b10</b> V1 Harmonics	<b>b9</b> THDV3	<b>b8</b> THDV2
<b>b23</b> S1	<b>b22</b> Q3	<b>b21</b> Q2	<b>b20</b> Q1	<b>b19</b> P3	<b>b18</b> P2	<b>b17</b> P1	<b>b16</b> IN
<b>b31</b> PF3	<b>b30</b> PF2	<b>b29</b> PF1	<b>b28</b> COSØ3	<b>b27</b> COSØ2	<b>b26</b> COSØ1	<b>b25</b> S3	<b>b24</b> S2

**Alarms 2**

<b>b7</b> I2 Harmonics	<b>b6</b> I1 Harmonics	<b>b5</b> THDV3	<b>b4</b> THDV2	<b>b3</b> THDV1	<b>b2</b> F3	<b>b1</b> F2	<b>b0</b> F1
<b>b15</b> Step2	<b>b14</b> Step1	<b>b13</b> Under Comp.	<b>b12</b> Over Comp.	<b>b11</b> Cap. Energy	<b>b10</b> Ind. Energy	<b>b9</b> Battery	<b>b8</b> I3 Harmonics
<b>b23</b> Step10	<b>b22</b> Step9	<b>b21</b> Step8	<b>b20</b> Step7	<b>b19</b> Step6	<b>b18</b> Step5	<b>b17</b> Step4	<b>b16</b> Step3
<b>b31</b> -	<b>b30</b> -	<b>b29</b> -	<b>b28</b> -	<b>b27</b> -	<b>b26</b> -	<b>b25</b> Step12	<b>b24</b> Step11

**Abbreviations used for the Alarm Flags are:**

<b>Temp.</b> : Temperature	<b>PF1</b> : Phase1 Power Factor
<b>V1</b> : Phase1 (L-N) Voltage	<b>PF2</b> : Phase2 Power Factor
<b>V2</b> : Phase2 (L-N) Voltage	<b>PF3</b> : Phase3 Power Factor
<b>V3</b> : Phase3 (L-N) Voltage	<b>F1</b> : Phase1 Frequency
<b>I1</b> : Phase1 Current	<b>F2</b> : Phase2 Frequency
<b>I2</b> : Phase2 Current	<b>F3</b> : Phase3 Frequency
<b>I3</b> : Phase3 Current	<b>THDI1</b> : Phase1 Total Harmonic Distortion in Current
<b>THDV1</b> : Phase1 Total Harmonic Distortion in Voltage	<b>THDI2</b> : Phase2 Total Harmonic Distortion in Current
<b>THDV2</b> : Phase2 Total Harmonic Distortion in Voltage	<b>THDI3</b> : Phase3 Total Harmonic Distortion in Current
<b>THDV3</b> : Phase3 Total Harmonic Distortion in Voltage	<b>I1 Harmonics</b> : Phase1 Current Harmonics
<b>V1 Harmonics</b> : Phase1 Voltage Harmonics	<b>I2 Harmonics</b> : Phase2 Current Harmonics
<b>V2 Harmonics</b> : Phase2 Voltage Harmonics	<b>I3 Harmonics</b> : Phase3 Current Harmonics
<b>V3 Harmonics</b> : Phase3 Voltage Harmonics	<b>Battery</b> : Battery Voltage
<b>VLL1</b> : Phase1-Phase2 Voltage	<b>Ind. Energy</b> : Inductive Energy
<b>VLL2</b> : Phase2-Phase3 Voltage	<b>Cap. Energy</b> : Capacitive Energy
<b>VLL3</b> : Phase3-Phase1 Voltage	<b>Over Comp.</b> : Over Compensation
<b>IN</b> : Neutral Current	<b>Under Comp.</b> : Under Compensation
<b>P1</b> : Phase1 Active Power	<b>Step1</b> : Step 1 Low Limit Value Alarm
<b>P2</b> : Phase2 Active Power	<b>Step2</b> : Step 2 Low Limit Value Alarm
<b>P3</b> : Phase3 Active Power	<b>Step3</b> : Step 3 Low Limit Value Alarm
<b>Q1</b> : Phase1 Reactive Power	<b>Step4</b> : Step 4 Low Limit Value Alarm
<b>Q2</b> : Phase2 Reactive Power	<b>Step5</b> : Step 5 Low Limit Value Alarm
<b>Q3</b> : Phase3 Reactive Power	<b>Step6</b> : Step 6 Low Limit Value Alarm
<b>S1</b> : Phase1 Apparent Power	<b>Step7</b> : Step 7 Low Limit Value Alarm
<b>S2</b> : Phase2 Apparent Power	<b>Step8</b> : Step 8 Low Limit Value Alarm
<b>S3</b> : Phase3 Apparent Power	<b>Step9</b> : Step 9 Low Limit Value Alarm
<b>CosØ1</b> : Phase1 CosØ	<b>Step10</b> : Step 10 Low Limit Value Alarm
<b>CosØ2</b> : Phase2 CosØ	<b>Step11</b> : Step 11 Low Limit Value Alarm
<b>CosØ3</b> : Phase3 CosØ	<b>Step12</b> : Step 12 Low Limit Value Alarm



### 4.5.1.2 Readable Data for RAPIDUS 232R-E

Table 4-5 Readable Data(RAPIDUS 232R-E)

Address	Parameter	Description	R/W	Unit	Data Type
0	V avg.	Average voltage of three phases	RO	V	32 bit float
2	I tot.	Total current of three phases	RO	A	32 bit float
4	P tot.	Total active power of three phases	RO	W	32 bit float
6	Q tot.	Total reactive power of three phases	RO	VAr	32 bit float
8	S tot.	Total apparent power of three phases	RO	VA	32 bit float
10	CosØ avg.	Average CosØ of three phases	RO	-	32 bit float
12	PF avg.	Average PF of three phases	RO	-	32 bit float
14	VLL12	Voltage V1-2	RO	V	32 bit float
16	VLL23	Voltage V2-3	RO	V	32 bit float
18	VLL31	Voltage V3-1	RO	V	32 bit float
20	VLL avg.	Average of line to line voltage of three phases	RO	V	32 bit float
22	IN	Neutral current	RO	A	32 bit float
24	THDV tot.	Total har. distortion of voltage for three phases	RO	%	32 bit float
26	THDI tot.	Total har. distortion of voltage for three phases	RO	%	32 bit float
<b>PHASE 1</b>					
28	L1 V	Phase1 voltage	RO	V	32 bit float
30	L1 I	Phase1 current	RO	A	32 bit float
32	L1 P	Phase1 active power	RO	W	32 bit float
34	L1 Q	Phase1 reactive power	RO	VAr	32 bit float
36	L1 S	Phase1 apparent power	RO	VA	32 bit float
38	L1 CosØ	Phase1 CosØ	RO	-	32 bit float
40	L1 PF	Phase1 power factor	RO	-	32 bit float
42	L1 F	Phase1 frequency	RO	Hz	32 bit float
44	L1 THDV	Phase1 total har. distortion of voltage	RO	%	32 bit float
46	L1 THDI	Phase1 total har. distortion of current	RO	%	32 bit float
48	L1 V Harmonics 1	Phase1 voltage first harmonic	RO	%	32 bit float
50	L1 V Harmonics 3	Phase1 voltage third harmonic	RO	%	32 bit float
52	L1 V Harmonics 5	Phase1 voltage 5th harmonic	RO	%	32 bit float
54	L1 V Harmonics 7	Phase1 voltage 7th harmonic	RO	%	32 bit float
56	L1 V Harmonics 9	Phase1 voltage 9th harmonic	RO	%	32 bit float
58	L1 V Harmonics 11	Phase1 voltage 11th harmonic	RO	%	32 bit float
60	L1 V Harmonics 13	Phase1 voltage 13th harmonic	RO	%	32 bit float
62	L1 V Harmonics 15	Phase1 voltage 15th harmonic	RO	%	32 bit float
64	L1 V Harmonics 17	Phase1 voltage 17th harmonic	RO	%	32 bit float
66	L1 V Harmonics 19	Phase1 voltage 19th harmonic	RO	%	32 bit float
68	L1 V Harmonics 21	Phase1 voltage 21st harmonic	RO	%	32 bit float
70	L1 V Harmonics 23	Phase1 voltage 23rd harmonic	RO	%	32 bit float
72	L1 V Harmonics 25	Phase1 voltage 25th harmonic	RO	%	32 bit float
74	L1 V Harmonics 27	Phase1 voltage 27th harmonic	RO	%	32 bit float
76	L1 V Harmonics 29	Phase1 voltage 29th harmonic	RO	%	32 bit float
78	L1 V Harmonics 31	Phase1 voltage 31st harmonic	RO	%	32 bit float

Address	Parameter	Description	R/W	Unit	Data Type
80	L1 V Harmonics 33	Phase1 voltage 33rd harmonic	RO	%	32 bit float
82	L1 V Harmonics 35	Phase1 voltage 35th harmonic	RO	%	32 bit float
84	L1 V Harmonics 37	Phase1 voltage 37th harmonic	RO	%	32 bit float
86	L1 V Harmonics 39	Phase1 voltage 39th harmonic	RO	%	32 bit float
88	L1 V Harmonics 41	Phase1 voltage 41st harmonic	RO	%	32 bit float
90	L1 V Harmonics 43	Phase1 voltage 43rd harmonic	RO	%	32 bit float
92	L1 V Harmonics 45	Phase1 voltage 45th harmonic	RO	%	32 bit float
94	L1 V Harmonics 47	Phase1 voltage 47th harmonic	RO	%	32 bit float
96	L1 V Harmonics 49	Phase1 voltage 49th harmonic	RO	%	32 bit float
98	L1 V Harmonics 51	Phase1 voltage 51st harmonic	RO	%	32 bit float
100	L1 I Harmonics 1	Phase1 current first harmonic	RO	%	32 bit float
102	L1 I Harmonics 3	Phase1 current third harmonic	RO	%	32 bit float
104	L1 I Harmonics 5	Phase1 current 5th harmonic	RO	%	32 bit float
106	L1 I Harmonics 7	Phase1 current 7th harmonic	RO	%	32 bit float
108	L1 I Harmonics 9	Phase1 current 9th harmonic	RO	%	32 bit float
110	L1 I Harmonics 11	Phase1 current 11th harmonic	RO	%	32 bit float
112	L1 I Harmonics 13	Phase1 current 13th harmonic	RO	%	32 bit float
114	L1 I Harmonics 15	Phase1 current 15th harmonic	RO	%	32 bit float
116	L1 I Harmonics 17	Phase1 current 17th harmonic	RO	%	32 bit float
118	L1 I Harmonics 19	Phase1 current 19th harmonic	RO	%	32 bit float
120	L1 I Harmonics 21	Phase1 current 21st harmonic	RO	%	32 bit float
122	L1 I Harmonics 23	Phase1 current 23rd harmonic	RO	%	32 bit float
124	L1 I Harmonics 25	Phase1 current 25th harmonic	RO	%	32 bit float
126	L1 I Harmonics 27	Phase1 current 27th harmonic	RO	%	32 bit float
128	L1 I Harmonics 29	Phase1 current 29th harmonic	RO	%	32 bit float
130	L1 I Harmonics 31	Phase1 current 31st harmonic	RO	%	32 bit float
132	L1 I Harmonics 33	Phase1 current 33rd harmonic	RO	%	32 bit float
134	L1 I Harmonics 35	Phase1 current 35th harmonic	RO	%	32 bit float
136	L1 I Harmonics 37	Phase1 current 37th harmonic	RO	%	32 bit float
138	L1 I Harmonics 39	Phase1 current 39th harmonic	RO	%	32 bit float
140	L1 I Harmonics 41	Phase1 current 41st harmonic	RO	%	32 bit float
142	L1 I Harmonics 43	Phase1 current 43rd harmonic	RO	%	32 bit float
144	L1 I Harmonics 45	Phase1 current 45th harmonic	RO	%	32 bit float
146	L1 I Harmonics 47	Phase1 current 47th harmonic	RO	%	32 bit float
148	L1 I Harmonics 49	Phase1 current 49th harmonic	RO	%	32 bit float
150	L1 I Harmonics 51	Phase1 current 51st harmonic	RO	%	32 bit float
<b>PHASE 2</b>					
152	L2 V	Phase2 voltage	RO	V	32 bit float
154	L2 I	Phase2 current	RO	A	32 bit float
156	L2 P	Phase2 active power	RO	W	32 bit float
158	L2 Q	Phase2 reactive power	RO	VAr	32 bit float
160	L2 S	Phase2 apparent power	RO	VA	32 bit float
162	L2 CosØ	Phase2 CosØ	RO	-	32 bit float
164	L2 PF	Phase2 power factor	RO	-	32 bit float

Address	Parameter	Description	R/W	Unit	Data Type
166	L2 F	Phase2 frequency	RO	Hz	32 bit float
168	L2 THDV	Phase2 total har. distortion of voltage	RO	%	32 bit float
170	L2 THDI	Phase2 total har. distortion of current	RO	%	32 bit float
172	L2 V Harmonics 1	Phase2 voltage first harmonic	RO	%	32 bit float
174	L2 V Harmonics 3	Phase2 voltage third harmonic	RO	%	32 bit float
176	L2 V Harmonics 5	Phase2 voltage 5th harmonic	RO	%	32 bit float
178	L2 V Harmonics 7	Phase2 voltage 7th harmonic	RO	%	32 bit float
180	L2 V Harmonics 9	Phase2 voltage 9th harmonic	RO	%	32 bit float
182	L2 V Harmonics 11	Phase2 voltage 11th harmonic	RO	%	32 bit float
184	L2 V Harmonics 13	Phase2 voltage 13th harmonic	RO	%	32 bit float
186	L2 V Harmonics 15	Phase2 voltage 15th harmonic	RO	%	32 bit float
188	L2 V Harmonics 17	Phase2 voltage 17th harmonic	RO	%	32 bit float
190	L2 V Harmonics 19	Phase2 voltage 19th harmonic	RO	%	32 bit float
192	L2 V Harmonics 21	Phase2 voltage 21st harmonic	RO	%	32 bit float
194	L2 V Harmonics 23	Phase2 voltage 23rd harmonic	RO	%	32 bit float
196	L2 V Harmonics 25	Phase2 voltage 25th harmonic	RO	%	32 bit float
198	L2 V Harmonics 27	Phase2 voltage 27th harmonic	RO	%	32 bit float
200	L2 V Harmonics 29	Phase2 voltage 29th harmonic	RO	%	32 bit float
202	L2 V Harmonics 31	Phase2 voltage 31st harmonic	RO	%	32 bit float
204	L2 V Harmonics 33	Phase2 voltage 33rd harmonic	RO	%	32 bit float
206	L2 V Harmonics 35	Phase2 voltage 35th harmonic	RO	%	32 bit float
208	L2 V Harmonics 37	Phase2 voltage 37th harmonic	RO	%	32 bit float
210	L2 V Harmonics 39	Phase2 voltage 39th harmonic	RO	%	32 bit float
212	L2 V Harmonics 41	Phase2 voltage 41st harmonic	RO	%	32 bit float
214	L2 V Harmonics 43	Phase2 voltage 43rd harmonic	RO	%	32 bit float
216	L2 V Harmonics 45	Phase2 voltage 45th harmonic	RO	%	32 bit float
218	L2 V Harmonics 47	Phase2 voltage 47th harmonic	RO	%	32 bit float
220	L2 V Harmonics 49	Phase2 voltage 49th harmonic	RO	%	32 bit float
222	L2 V Harmonics 51	Phase2 voltage 51st harmonic	RO	%	32 bit float
224	L2 I Harmonics 1	Phase2 current first harmonic	RO	%	32 bit float
226	L2 I Harmonics 3	Phase2 current third harmonic	RO	%	32 bit float
228	L2 I Harmonics 5	Phase2 current 5th harmonic	RO	%	32 bit float
230	L2 I Harmonics 7	Phase2 current 7th harmonic	RO	%	32 bit float
232	L2 I Harmonics 9	Phase2 current 9th harmonic	RO	%	32 bit float
234	L2 I Harmonics 11	Phase2 current 11th harmonic	RO	%	32 bit float
236	L2 I Harmonics 13	Phase2 current 13th harmonic	RO	%	32 bit float
238	L2 I Harmonics 15	Phase2 current 15th harmonic	RO	%	32 bit float
240	L2 I Harmonics 17	Phase2 current 17th harmonic	RO	%	32 bit float
242	L2 I Harmonics 19	Phase2 current 19th harmonic	RO	%	32 bit float
244	L2 I Harmonics 21	Phase2 current 21st harmonic	RO	%	32 bit float
246	L2 I Harmonics 23	Phase2 current 23rd harmonic	RO	%	32 bit float
248	L2 I Harmonics 25	Phase2 current 25th harmonic	RO	%	32 bit float
250	L2 I Harmonics 27	Phase2 current 27th harmonic	RO	%	32 bit float
252	L2 I Harmonics 29	Phase2 current 29th harmonic	RO	%	32 bit float

Address	Parameter	Description	R/W	Unit	Data Type
254	L2 I Harmonics 31	Phase2 current 31st harmonic	RO	%	32 bit float
256	L2 I Harmonics 33	Phase2 current 33rd harmonic	RO	%	32 bit float
258	L2 I Harmonics 35	Phase2 current 35th harmonic	RO	%	32 bit float
260	L2 I Harmonics 37	Phase2 current 37th harmonic	RO	%	32 bit float
262	L2 I Harmonics 39	Phase2 current 39th harmonic	RO	%	32 bit float
264	L2 I Harmonics 41	Phase2 current 41st harmonic	RO	%	32 bit float
266	L2 I Harmonics 43	Phase2 current 43rd harmonic	RO	%	32 bit float
268	L2 I Harmonics 45	Phase2 current 45th harmonic	RO	%	32 bit float
270	L2 I Harmonics 47	Phase2 current 47th harmonic	RO	%	32 bit float
272	L2 I Harmonics 49	Phase2 current 49th harmonic	RO	%	32 bit float
274	L2 I Harmonics 51	Phase2 current 51st harmonic	RO	%	32 bit float
<b>PHASE 3</b>					
276	L3 V	Phase3 voltage	RO	V	32 bit float
278	L3 I	Phase3 current	RO	A	32 bit float
280	L3 P	Phase3 active power	RO	W	32 bit float
282	L3 Q	Phase3 reactive power	RO	VAr	32 bit float
284	L3 S	Phase3 apparent power	RO	VA	32 bit float
286	L3 CosØ	Phase3 CosØ	RO	-	32 bit float
288	L3 PF	Phase3 power factor	RO	-	32 bit float
290	L3 F	Phase3 frequency	RO	Hz	32 bit float
292	L3 THDV	Phase3 total har. distortion of voltage	RO	%	32 bit float
294	L3 THDI	Phase3 total har. distortion of current	RO	%	32 bit float
296	L3 V Harmonics 1	Phase3 voltage first harmonic	RO	%	32 bit float
298	L3 V Harmonics 3	Phase3 voltage third harmonic	RO	%	32 bit float
300	L3 V Harmonics 5	Phase3 voltage 5th harmonic	RO	%	32 bit float
302	L3 V Harmonics 7	Phase3 voltage 7th harmonic	RO	%	32 bit float
304	L3 V Harmonics 9	Phase3 voltage 9th harmonic	RO	%	32 bit float
306	L3 V Harmonics 11	Phase3 voltage 11th harmonic	RO	%	32 bit float
308	L3 V Harmonics 13	Phase3 voltage 13th harmonic	RO	%	32 bit float
310	L3 V Harmonics 15	Phase3 voltage 15th harmonic	RO	%	32 bit float
312	L3 V Harmonics 17	Phase3 voltage 17th harmonic	RO	%	32 bit float
314	L3 V Harmonics 19	Phase3 voltage 19th harmonic	RO	%	32 bit float
316	L3 V Harmonics 21	Phase3 voltage 21st harmonic	RO	%	32 bit float
318	L3 V Harmonics 23	Phase3 voltage 23rd harmonic	RO	%	32 bit float
320	L3 V Harmonics 25	Phase3 voltage 25th harmonic	RO	%	32 bit float
322	L3 V Harmonics 27	Phase3 voltage 27th harmonic	RO	%	32 bit float
324	L3 V Harmonics 29	Phase3 voltage 29th harmonic	RO	%	32 bit float
326	L3 V Harmonics 31	Phase3 voltage 31st harmonic	RO	%	32 bit float
328	L3 V Harmonics 33	Phase3 voltage 33rd harmonic	RO	%	32 bit float
330	L3 V Harmonics 35	Phase3 voltage 35th harmonic	RO	%	32 bit float
332	L3 V Harmonics 37	Phase3 voltage 37th harmonic	RO	%	32 bit float
334	L3 V Harmonics 39	Phase3 voltage 39th harmonic	RO	%	32 bit float
336	L3 V Harmonics 41	Phase3 voltage 41st harmonic	RO	%	32 bit float
338	L3 V Harmonics 43	Phase3 voltage 43rd harmonic	RO	%	32 bit float



Address	Parameter	Description	R/W	Unit	Data Type
340	L3 V Harmonics 45	Phase3 voltage 45th harmonic	RO	%	32 bit float
342	L3 V Harmonics 47	Phase3 voltage 47th harmonic	RO	%	32 bit float
344	L3 V Harmonics 49	Phase3 voltage 49th harmonic	RO	%	32 bit float
346	L3 V Harmonics 51	Phase3 voltage 51st harmonic	RO	%	32 bit float
348	L3 I Harmonics 1	Phase3 current first harmonic	RO	%	32 bit float
350	L3 I Harmonics 3	Phase3 current third harmonic	RO	%	32 bit float
352	L3 I Harmonics 5	Phase3 current 5th harmonic	RO	%	32 bit float
354	L3 I Harmonics 7	Phase3 current 7th harmonic	RO	%	32 bit float
356	L3 I Harmonics 9	Phase3 current 9th harmonic	RO	%	32 bit float
358	L3 I Harmonics 11	Phase3 current 11th harmonic	RO	%	32 bit float
360	L3 I Harmonics 13	Phase3 current 13th harmonic	RO	%	32 bit float
362	L3 I Harmonics 15	Phase3 current 15th harmonic	RO	%	32 bit float
364	L3 I Harmonics 17	Phase3 current 17th harmonic	RO	%	32 bit float
366	L3 I Harmonics 19	Phase3 current 19th harmonic	RO	%	32 bit float
368	L3 I Harmonics 21	Phase3 current 21st harmonic	RO	%	32 bit float
370	L3 I Harmonics 23	Phase3 current 23rd harmonic	RO	%	32 bit float
372	L3 I Harmonics 25	Phase3 current 25th harmonic	RO	%	32 bit float
374	L3 I Harmonics 27	Phase3 current 27th harmonic	RO	%	32 bit float
376	L3 I Harmonics 29	Phase3 current 29th harmonic	RO	%	32 bit float
378	L3 I Harmonics 31	Phase3 current 31st harmonic	RO	%	32 bit float
380	L3 I Harmonics 33	Phase3 current 33rd harmonic	RO	%	32 bit float
382	L3 I Harmonics 35	Phase3 current 35th harmonic	RO	%	32 bit float
384	L3 I Harmonics 37	Phase3 current 37th harmonic	RO	%	32 bit float
386	L3 I Harmonics 39	Phase3 current 39th harmonic	RO	%	32 bit float
388	L3 I Harmonics 41	Phase3 current 41st harmonic	RO	%	32 bit float
390	L3 I Harmonics 43	Phase3 current 43rd harmonic	RO	%	32 bit float
392	L3 I Harmonics 45	Phase3 current 45th harmonic	RO	%	32 bit float
394	L3 I Harmonics 47	Phase3 current 47th harmonic	RO	%	32 bit float
396	L3 I Harmonics 49	Phase3 current 49th harmonic	RO	%	32 bit float
398	L3 I Harmonics 51	Phase3 current 51st harmonic	RO	%	32 bit float
<b>ALARM FLAGS</b>					
400	Alarms 1	Alarm flag 1 (first 32 bit)	RO	-	32 bit int.
402	Alarms 2	Alarm flag 2 (second 32 bit)	RO	-	32 bit int.
<b>STEP VARIABLES</b>					
404	Active step	Active step flags	RO	-	32 bit int.
406	Available step	Available step flags	RO	-	32 bit int.
408	Fixed step	Fixed step flags	RO	-	32 bit int.
410	S1 switching count	Step 1 switching count	RO	-	32 bit int.
412	S2 switching count	Step 2 switching count	RO	-	32 bit int.
414	S3 switching count	Step 3 switching count	RO	-	32 bit int.
416	S4 switching count	Step 4 switching count	RO	-	32 bit int.
418	S5 switching count	Step 5 switching count	RO	-	32 bit int.
420	S6 switching count	Step 6 switching count	RO	-	32 bit int.
422	S7 switching count	Step 7 switching count	RO	-	32 bit int.

Address	Parameter	Description	R/W	Unit	Data Type
424	S8 switching count	Step 8 switching count	RO	-	32 bit int.
426	S9 switching count	Step 9 switching count	RO	-	32 bit int.
428	S10 switching count	Step 10 switching count	RO	-	32 bit int.
430	S11 switching count	Step 11 switching count	RO	-	32 bit int.
432	S12 switching count	Step 12 switching count	RO	-	32 bit int.
434	S13 switching count	Step 13 switching count	RO	-	32 bit int.
436	S14 switching count	Step 14 switching count	RO	-	32 bit int.
438	S15 switching count	Step 15 switching count	RO	-	32 bit int.
440	S16 switching count	Step 16 switching count	RO	-	32 bit int.
442	S17 switching count	Step 17 switching count	RO	-	32 bit int.
444	S18 switching count	Step 18 switching count	RO	-	32 bit int.
446	S19 switching count	Step 19 switching count	RO	-	32 bit int.
448	S20 switching count	Step 20 switching count	RO	-	32 bit int.
450	S21 switching count	Step 21 switching count	RO	-	32 bit int.
452	S22 switching count	Step 22 switching count	RO	-	32 bit int.
454	S23 switching count	Step 23 switching count	RO	-	32 bit int.
456	S24 switching count	Step 24 switching count	RO	-	32 bit int.
458	S1 operation time	Step 1 operation time	RO	min.	32 bit int.
460	S2 operation time	Step 2 operation time	RO	min.	32 bit int.
462	S3 operation time	Step 3 operation time	RO	min.	32 bit int.
464	S4 operation time	Step 4 operation time	RO	min.	32 bit int.
466	S5 operation time	Step 5 operation time	RO	min.	32 bit int.
468	S6 operation time	Step 6 operation time	RO	min.	32 bit int.
470	S7 operation time	Step 7 operation time	RO	min.	32 bit int.
472	S8 operation time	Step 8 operation time	RO	min.	32 bit int.
474	S9 operation time	Step 9 operation time	RO	min.	32 bit int.
476	S10 operation time	Step 10 operation time	RO	min.	32 bit int.
478	S11 operation time	Step 11 operation time	RO	min.	32 bit int.
480	S12 operation time	Step 12 operation time	RO	min.	32 bit int.
482	S13 operation time	Step 13 operation time	RO	min.	32 bit int.
484	S14 operation time	Step 14 operation time	RO	min.	32 bit int.
486	S15 operation time	Step 15 operation time	RO	min.	32 bit int.
488	S16 operation time	Step 16 operation time	RO	min.	32 bit int.
490	S17 operation time	Step 17 operation time	RO	min.	32 bit int.
492	S18 operation time	Step 18 operation time	RO	min.	32 bit int.
494	S19 operation time	Step 19 operation time	RO	min.	32 bit int.
496	S20 operation time	Step 20 operation time	RO	min.	32 bit int.
498	S21 operation time	Step 21 operation time	RO	min.	32 bit int.
500	S22 operation time	Step 22 operation time	RO	min.	32 bit int.
502	S23 operation time	Step 23 operation time	RO	min.	32 bit int.
504	S24 operation time	Step 24 operation time	RO	min.	32 bit int.
<b>ENERGY METERS (32 bit)</b>					
506	T1 Imp. Act. Index	Tariff 1 Import Active Index	RO	kWh	32 bit float
508	T1 Imp. Act. Curr. Hour	Tariff 1 Import Active Current Hour	RO	kWh	32 bit float

Address	Parameter	Description	R/W	Unit	Data Type
510	T1 Imp. Act. Prev. Hour	Tariff 1 Import Active Previous Hour	RO	kWh	32 bit float
512	T1 Imp. Act. Curr. Day	Tariff 1 Import. Active Current Day	RO	kWh	32 bit float
514	T1 Imp. Act. Prev. Day	Tariff 1 Import Active Previous Day	RO	kWh	32 bit float
516	T1 Imp. Act. Curr. Month	Tariff 1 Import Active Current Month	RO	kWh	32 bit float
518	T1 Imp. Act. Prev. Month	Tariff 1 Import Previous Month	RO	kWh	32 bit float
520	T1 Exp. Act. Index	Tariff 1 Export Active Index	RO	kWh	32 bit float
522	T1 Exp. Act. Curr. Hour	Tariff 1 Export Active Current Hour	RO	kWh	32 bit float
524	T1 Exp. Act. Prev. Hour	Tariff 1 Export Active Previous Hour	RO	kWh	32 bit float
526	T1 Exp. Act. Curr. Day	Tariff 1 Export Active Current Day	RO	kWh	32 bit float
528	T1 Exp. Act. Prev. Day	Tariff 1 Export Active Previous Day	RO	kWh	32 bit float
530	T1 Exp. Act. Curr. Month	Tariff 1 Export Active Current Month	RO	kWh	32 bit float
532	T1 Exp. Act. Prev. Month	Tariff 1 Export Active Previous Month	RO	kWh	32 bit float
534	T1 Ind. React. Index	Tariff 1 Inductive Reactive Index	RO	kVAh	32 bit float
536	T1 Ind. React. Curr. Hour	Tariff 1 Inductive Reactive Current Hour	RO	kVAh	32 bit float
538	T1 Ind. React. Prev. Hour	Tariff 1 Inductive Reactive Previous Hour	RO	kVAh	32 bit float
540	T1 Ind. React. Curr. Day	Tariff 1 Inductive Reactive Current Day	RO	kVAh	32 bit float
542	T1 Ind. React. Prev. Day	Tariff 1 Inductive Reactive Previous Day	RO	kVAh	32 bit float
544	T1 Ind. React. Curr. Month	Tariff 1 Inductive Reactive Current Month	RO	kVAh	32 bit float
546	T1 Ind. React. Prev. Month	Tariff 1 Inductive Reactive Previous Month	RO	kVAh	32 bit float
548	T1 Cap. React. Index	Tariff 1 Capacitive Reactive Index	RO	kVAh	32 bit float
550	T1 Cap. React. Curr. Hour	Tariff 1 Capacitive Reactive Current Hour	RO	kVAh	32 bit float
552	T1 Cap. React. Prev. Hour	Tariff 1 Capacitive Reactive Previous Hour	RO	kVAh	32 bit float
554	T1 Cap. React. Curr. Day	Tariff 1 Capacitive Reactive Current Day	RO	kVAh	32 bit float
556	T1 Cap. React. Prev. Day	Tariff 1 Capacitive Reactive Previous Day	RO	kVAh	32 bit float
558	T1 Cap. React. Curr. Month	Tariff 1 Capacitive Reactive Current Month	RO	kVAh	32 bit float
560	T1 Cap. React. Prev. Month	Tariff 1 Capacitive Reactive Previous Month	RO	kVAh	32 bit float
<b>DEMAND</b>					
562	Curr. Month P tot.	Current Month Total Active Power	RO	W	32 bit float
564	Curr. Month P tot. time	Current Month Total Active Power Timestamp	RO	-	32 bit unix time
566	Curr. Month I tot.	Current Month Total Current	RO	A	32 bit float
568	Curr. Month I tot. time	Current Month Total Current Timestamp	RO	-	32 bit unix time
570	Curr. Month Q tot.	Current Month Total Reactive Power	RO	VA	32 bit float
572	Curr. Month Q tot. time	Current Month Total Reactive Power Timestamp	RO	-	32 bit unix time
574	Curr. Month S tot.	Current Month Total Apparent Power	RO	VA	32 bit float
576	Curr. Month S tot. time	Current Month Total Apparent Power Timestamp	RO	-	32 bit unix time
578	Curr. Month L1 P	Current Month Phase 1 Active Power	RO	W	32 bit float
580	Curr. Month L1 P time	Current Month Phase 1 Active Power Timestamp	RO	-	32 bit unix time
582	Curr. Month L1 I	Current Month Phase 1 Current	RO	A	32 bit float
584	Curr. Month L1 I time	Current Month Phase 1 Current Timestamp	RO	-	32 bit unix time
586	Curr. Month L1 Q	Current Month Phase 1 Reactive Power	RO	VA	32 bit float
588	Curr. Month L1 Q time	Current Month Phase 1 Reactive Power Timestamp	RO	-	32 bit unix time

Address	Parameter	Description	R/W	Unit	Data Type
590	Curr. Month L1 S	Current Month Phase 1 Apparent Power	RO	VA	32 bit float
592	Curr. Month L1 S time	Current Month Phase 1 Apparent Power Timestamp	RO	-	32 bit unix time
594	Curr. Month L2 P	Current Month Phase 2 Active Power	RO	W	32 bit float
596	Curr. Month L2 P time	Current Month Phase 2 Active Power Timestamp	RO	-	32 bit unix time
598	Curr. Month L2 I	Current Month Phase 2 Current	RO	A	32 bit float
600	Curr. Month L2 I time	Current Month Phase 2 Current Timestamp	RO	-	32 bit unix time
602	Curr. Month L2 Q	Current Month Phase 2 Reactive Power	RO	VAr	32 bit float
604	Curr. Month L2 Q time	Current Month Phase 2 Reactive Power Timestamp	RO	-	32 bit unix time
606	Curr. Month L2 S	Current Month Phase 2 Apparent Power	RO	VA	32 bit float
608	Curr. Month L2 S time	Current Month Phase 2 Apparent Power Timestamp	RO	-	32 bit unix time
610	Curr. Month L3 P	Current Month Phase 3 Active Power	RO	W	32 bit float
612	Curr. Month L3 P time	Current Month Phase 3 Active Power Timestamp	RO	-	32 bit unix time
614	Curr. Month L3 I	Current Month Phase 3 Current	RO	A	32 bit float
616	Curr. Month L3 I time	Current Month Phase 3 Current Timestamp	RO	-	32 bit unix time
618	Curr. Month L3 Q	Current Month Phase 3 Reactive Power	RO	VAr	32 bit float
620	Curr. Month L3 Q time	Current Month Phase 3 Reactive Power Timestamp	RO	-	32 bit unix time
622	Curr. Month L3 S	Current Month Phase 3 Apparent Power	RO	VA	32 bit float
624	Curr. Month L3 S time	Current Month Phase 3 Apparent Power Timestamp	RO	-	32 bit unix time
<b>OTHER</b>					
626	Temp.	Temperature Value	RO	°C	32 bit float
628	Battery Voltage	-	RO	V	32 bit float
630	Time	System Date and Time	R/W	-	32 bit unix time
<b>ALARM STATUSES</b>					
632	1 - Alarm Timestamp	1 - Alarm time	RO	-	32 bit unix time
634	1 - Alarm ID	1 - Alarm ID	RO	-	32 bit int.
636	1 - Alarm Status	1 - Alarm ON /Alarm OFF status	RO	-	32 bit int.
638	1 - Alarm Value	1 - Value of related alarm parameter	RO	-	32 bit float
640	2 - Alarm Timestamp	2 - Alarm time	RO	-	32 bit unix time
642	2 - Alarm ID	2 - Alarm ID	RO	-	32 bit int.
644	2 - Alarm Status	2 - Alarm ON /Alarm OFF status	RO	-	32 bit int.
646	2 - Alarm Value	2 - Value of related alarm parameter	RO	-	32 bit float
648	3 - Alarm Timestamp	3 - Alarm time	RO	-	32 bit unix time
650	3 - Alarm ID	3 - Alarm ID	RO	-	32 bit int.
652	3 - Alarm Status	3 - Alarm ON /Alarm OFF status	RO	-	32 bit int.
654	3 - Alarm Value	3 - Value of related alarm parameter	RO	-	32 bit float
656	4 - Alarm Timestamp	4 - Alarm time	RO	-	32 bit unix time
658	4 - Alarm ID	4 - Alarm ID	RO	-	32 bit int.
660	4 - Alarm Status	4 - Alarm ON /Alarm OFF status	RO	-	32 bit int.
662	4 - Alarm Value	4 - Value of related alarm parameter	RO	-	32 bit float

Address	Parameter	Description	R/W	Unit	Data Type
664	5 - Alarm Timestamp	5 - Alarm time	RO	-	32 bit unix time
666	5 - Alarm ID	5 - Alarm ID	RO	-	32 bit int.
668	5 - Alarm Status	5 - Alarm ON /Alarm OFF status	RO	-	32 bit int.
670	5 - Alarm Value	5 - Value of related alarm parameter	RO	-	32 bit float
672	6 - Alarm Timestamp	6 - Alarm time	RO	-	32 bit unix time
674	6 - Alarm ID	6 - Alarm ID	RO	-	32 bit int.
676	6 - Alarm Status	6 - Alarm ON /Alarm OFF status	RO	-	32 bit int.
678	6 - Alarm Value	6 - Value of related alarm parameter	RO	-	32 bit float
680	7 - Alarm Timestamp	7 - Alarm time	RO	-	32 bit unix time
682	7 - Alarm ID	7 - Alarm ID	RO	-	32 bit int.
684	7 - Alarm Status	7 - Alarm ON /Alarm OFF status	RO	-	32 bit int.
686	7 - Alarm Value	7 - Value of related alarm parameter	RO	-	32 bit float
688	8 - Alarm Timestamp	8 - Alarm time	RO	-	32 bit unix time
690	8 - Alarm ID	8 - Alarm ID	RO	-	32 bit int.
692	8 - Alarm Status	8 - Alarm ON /Alarm OFF status	RO	-	32 bit int.
694	8 - Alarm Value	8 - Value of related alarm parameter	RO	-	32 bit float
696	9 - Alarm Timestamp	9 - Alarm time	RO	-	32 bit unix time
698	9 - Alarm ID	9 - Alarm ID	RO	-	32 bit int.
700	9 - Alarm Status	9 - Alarm ON /Alarm OFF status	RO	-	32 bit int.
702	9 - Alarm Value	9 - Value of related alarm parameter	RO	-	32 bit float
704	10 - Alarm Timestamp	10 - Alarm time	RO	-	32 bit unix time
706	10 - Alarm ID	10 - Alarm ID	RO	-	32 bit int.
708	10 - Alarm Status	10 - Alarm ON /Alarm OFF status	RO	-	32 bit int.
710	10 - Alarm Value	10 - Value of related alarm parameter	RO	-	32 bit float
712	11 - Alarm Timestamp	11 - Alarm time	RO	-	32 bit unix time
714	11 - Alarm ID	11 - Alarm ID	RO	-	32 bit int.
716	11 - Alarm Status	11 - Alarm ON /Alarm OFF status	RO	-	32 bit int.
718	11 - Alarm Value	11 - Value of related alarm parameter	RO	-	32 bit float
720	12 - Alarm Timestamp	12 - Alarm time	RO	-	32 bit unix time
722	12 - Alarm ID	12 - Alarm ID	RO	-	32 bit int.
724	12 - Alarm Status	12 - Alarm ON /Alarm OFF status	RO	-	32 bit int.
726	12 - Alarm Value	12 - Value of related alarm parameter	RO	-	32 bit float
728	13 - Alarm Timestamp	13 - Alarm time	RO	-	32 bit unix time
730	13 - Alarm ID	13 - Alarm ID	RO	-	32 bit int.
732	13 - Alarm Status	13 - Alarm ON /Alarm OFF status	RO	-	32 bit int.
734	13 - Alarm Value	13 - Value of related alarm parameter	RO	-	32 bit float
736	14 - Alarm Timestamp	14 - Alarm time	RO	-	32 bit unix time
738	14 - Alarm ID	14 - Alarm ID	RO	-	32 bit int.
740	14 - Alarm Status	14 - Alarm ON /Alarm OFF status	RO	-	32 bit int.
742	14 - Alarm Value	14 - Value of related alarm parameter	RO	-	32 bit float
744	15 - Alarm Timestamp	15 - Alarm zaman değeri	RO	-	32 bit unix time
746	15 - Alarm ID	15 - Alarm ID	RO	-	32 bit int.
748	15 - Alarm Status	15 - Alarm ON /Alarm OFF status	RO	-	32 bit int.
750	15 - Alarm Value	15 - Value of related alarm parameter	RO	-	32 bit float

Address	Parameter	Description	R/W	Unit	Data Type
752	16 - Alarm Timestamp	16 - Alarm time	RO	-	32 bit unix time
754	16 - Alarm ID	16 - Alarm ID	RO	-	32 bit int.
756	16 - Alarm Status	16 - Alarm ON /Alarm OFF status	RO	-	32 bit int.
758	16 - Alarm Value	16 - Value of related alarm parameter	RO	-	32 bit float
760	17 - Alarm Timestamp	17 - Alarm time	RO	-	32 bit unix time
762	17 - Alarm ID	17 - Alarm ID	RO	-	32 bit int.
764	17 - Alarm Status	17 - Alarm ON /Alarm OFF status	RO	-	32 bit int.
766	17 - Alarm Value	17 - Value of related alarm parameter	RO	-	32 bit float
768	18 - Alarm Timestamp	18 - Alarm time	RO	-	32 bit unix time
770	18 - Alarm ID	18 - Alarm ID	RO	-	32 bit int.
772	18 - Alarm Status	18 - Alarm ON /Alarm OFF status	RO	-	32 bit int.
774	18 - Alarm Value	18 - Value of related alarm parameter	RO	-	32 bit float
776	19 - Alarm Timestamp	19 - Alarm time	RO	-	32 bit unix time
778	19 - Alarm ID	19 - Alarm ID	RO	-	32 bit int.
780	19 - Alarm Status	19 - Alarm ON /Alarm OFF status	RO	-	32 bit int.
782	19 - Alarm Value	19 - Value of related alarm parameter	RO	-	32 bit float
784	20 - Alarm Timestamp	20 - Alarm time	RO	-	32 bit unix time
786	20 - Alarm ID	20 - Alarm ID	RO	-	32 bit int.
788	20 - Alarm Status	20 - Alarm ON /Alarm OFF status	RO	-	32 bit int.
790	20 - Alarm Value	20 - Value of related alarm parameter	RO	-	32 bit float
792	21 - Alarm Timestamp	21 - Alarm time	RO	-	32 bit unix time
794	21 - Alarm ID	21 - Alarm ID	RO	-	32 bit int.
796	21 - Alarm Status	21 - Alarm ON /Alarm OFF status	RO	-	32 bit int.
798	21 - Alarm Value	21 - Value of related alarm parameter	RO	-	32 bit float
800	22 - Alarm Timestamp	22 - Alarm time	RO	-	32 bit unix time
802	22 - Alarm ID	22 - Alarm ID	RO	-	32 bit int.
804	22 - Alarm Status	22 - Alarm ON /Alarm OFF status	RO	-	32 bit int.
806	22 - Alarm Value	22 - Value of related alarm parameter	RO	-	32 bit float
808	23 - Alarm Timestamp	23 - Alarm time	RO	-	32 bit unix time
810	23 - Alarm ID	23 - Alarm ID	RO	-	32 bit int.
812	23 - Alarm Status	23 - Alarm ON /Alarm OFF status	RO	-	32 bit int.
814	23 - Alarm Value	23 - Value of related alarm parameter	RO	-	32 bit float
816	24 - Alarm Timestamp	24 - Alarm time	RO	-	32 bit unix time
818	24 - Alarm ID	24 - Alarm ID	RO	-	32 bit int.
820	24 - Alarm Status	24 - Alarm ON /Alarm OFF status	RO	-	32 bit int.
822	24 - Alarm Value	24 - Value of related alarm parameter	RO	-	32 bit float
824	25 - Alarm Timestamp	25 - Alarm time	RO	-	32 bit unix time
826	25 - Alarm ID	25 - Alarm ID	RO	-	32 bit int.
828	25 - Alarm Status	25 - Alarm ON /Alarm OFF status	RO	-	32 bit int.
830	25 - Alarm Value	25 - Value of related alarm parameter	RO	-	32 bit float
832	26 - Alarm Timestamp	26 - Alarm time	RO	-	32 bit unix time
834	26 - Alarm ID	26 - Alarm ID	RO	-	32 bit int.
836	26 - Alarm Status	26 - Alarm ON /Alarm OFF status	RO	-	32 bit int.
838	26 - Alarm Value	26 - Value of related alarm parameter	RO	-	32 bit float

Address	Parameter	Description	R/W	Unit	Data Type
840	27 - Alarm Timestamp	27 - Alarm time	RO	-	32 bit unix time
842	27 - Alarm ID	27 - Alarm ID	RO	-	32 bit int.
844	27 - Alarm Status	27 - Alarm ON /Alarm OFF status	RO	-	32 bit int.
846	27 - Alarm Value	27 - Value of related alarm parameter	RO	-	32 bit float
848	28 - Alarm Timestamp	28 - Alarm time	RO	-	32 bit unix time
850	28 - Alarm ID	28 - Alarm ID	RO	-	32 bit int.
852	28 - Alarm Status	28 - Alarm ON /Alarm OFF status	RO	-	32 bit int.
854	28 - Alarm Value	28 - Value of related alarm parameter	RO	-	32 bit float
856	29 - Alarm Timestamp	29 - Alarm time	RO	-	32 bit unix time
858	29 - Alarm ID	29 - Alarm ID	RO	-	32 bit int.
860	29 - Alarm Status	29 - Alarm ON /Alarm OFF status	RO	-	32 bit int.
862	29 - Alarm Value	29 - Value of related alarm parameter	RO	-	32 bit float
864	30 - Alarm Timestamp	30 - Alarm time	RO	-	32 bit unix time
866	30 - Alarm ID	30 - Alarm ID	RO	-	32 bit int.
868	30 - Alarm Status	30 - Alarm ON /Alarm OFF status	RO	-	32 bit int.
870	30 - Alarm Value	30 - Value of related alarm parameter	RO	-	32 bit float
872	31 - Alarm Timestamp	31 - Alarm time	RO	-	32 bit unix time
874	31 - Alarm ID	31 - Alarm ID	RO	-	32 bit int.
876	31 - Alarm Status	31 - Alarm ON /Alarm OFF status	RO	-	32 bit int.
878	31 - Alarm Value	31 - Value of related alarm parameter	RO	-	32 bit float
880	31 - Alarm Timestamp	32 - Alarm time	RO	-	32 bit unix time
882	32 - Alarm ID	32 - Alarm ID	RO	-	32 bit int.
884	32 - Alarm Status	32 - Alarm ON /Alarm OFF status	RO	-	32 bit int.
886	32 - Alarm Value	32 - Value of related alarm parameter	RO	-	32 bit float
888	33 - Alarm Timestamp	33 - Alarm time	RO	-	32 bit unix time
890	33 - Alarm ID	33 - Alarm ID	RO	-	32 bit int.
892	33 - Alarm Status	33 - Alarm ON /Alarm OFF status	RO	-	32 bit int.
894	33 - Alarm Value	33 - Value of related alarm parameter	RO	-	32 bit float
896	34 - Alarm Timestamp	34 - Alarm time	RO	-	32 bit unix time
898	34 - Alarm ID	34 - Alarm ID	RO	-	32 bit int.
900	34 - Alarm Status	34 - Alarm ON /Alarm OFF status	RO	-	32 bit int.
902	34 - Alarm Value	34 - Value of related alarm parameter	RO	-	32 bit float
904	35 - Alarm Timestamp	35 - Alarm time	RO	-	32 bit unix time
906	35 - Alarm ID	35 - Alarm ID	RO	-	32 bit int.
908	35 - Alarm Status	35 - Alarm ON /Alarm OFF status	RO	-	32 bit int.
910	35 - Alarm Value	35 - Value of related alarm parameter	RO	-	32 bit float
912	36 - Alarm Timestamp	36 - Alarm time	RO	-	32 bit unix time
914	36 - Alarm ID	36 - Alarm ID	RO	-	32 bit int.
916	36 - Alarm Status	36 - Alarm ON /Alarm OFF status	RO	-	32 bit int.
918	36 - Alarm Value	36 - Value of related alarm parameter	RO	-	32 bit float
920	37 - Alarm Timestamp	37 - Alarm time	RO	-	32 bit unix time
922	37 - Alarm ID	37 - Alarm ID	RO	-	32 bit int.
924	37 - Alarm Status	37 - Alarm ON /Alarm OFF status	RO	-	32 bit int.
926	37 - Alarm Value	37 - Value of related alarm parameter	RO	-	32 bit float

Address	Parameter	Description	R/W	Unit	Data Type
928	38 - Alarm Timestamp	38 - Alarm time	RO	-	32 bit unix time
930	38 - Alarm ID	38 - Alarm ID	RO	-	32 bit int.
932	38 - Alarm Status	38 - Alarm ON /Alarm OFF status	RO	-	32 bit int.
934	38 - Alarm Value	38 - Value of related alarm parameter	RO	-	32 bit float
936	39 - Alarm Timestamp	39 - Alarm time	RO	-	32 bit unix time
938	39 - Alarm ID	39 - Alarm ID	RO	-	32 bit int.
940	39 - Alarm Status	39 - Alarm ON /Alarm OFF status	RO	-	32 bit int.
942	39 - Alarm Value	39 - Value of related alarm parameter	RO	-	32 bit float
944	40 - Alarm Timestamp	40 - Alarm time	RO	-	32 bit unix time
946	40 - Alarm ID	40 - Alarm ID	RO	-	32 bit int.
948	40 - Alarm Status	40 - Alarm ON /Alarm OFF status	RO	-	32 bit int.
950	40 - Alarm Value	40 - Value of related alarm parameter	RO	-	32 bit float
952	41 - Alarm Timestamp	41 - Alarm time	RO	-	32 bit unix time
954	41 - Alarm ID	41 - Alarm ID	RO	-	32 bit int.
956	41 - Alarm Status	41 - Alarm ON /Alarm OFF status	RO	-	32 bit int.
958	41 - Alarm Value	41 - Value of related alarm parameter	RO	-	32 bit float
960	42 - Alarm Timestamp	42 - Alarm time	RO	-	32 bit unix time
962	42 - Alarm ID	42 - Alarm ID	RO	-	32 bit int.
964	42 - Alarm Status	42 - Alarm ON /Alarm OFF status	RO	-	32 bit int.
966	42 - Alarm Value	42 - Value of related alarm parameter	RO	-	32 bit float
968	43 - Alarm Timestamp	43 - Alarm time	RO	-	32 bit unix time
970	43 - Alarm ID	43 - Alarm ID	RO	-	32 bit int.
972	43 - Alarm Status	43 - Alarm ON /Alarm OFF status	RO	-	32 bit int.
974	43 - Alarm Value	43 - Value of related alarm parameter	RO	-	32 bit float
976	44 - Alarm Timestamp	44 - Alarm time	RO	-	32 bit unix time
978	44 - Alarm ID	44 - Alarm ID	RO	-	32 bit int.
980	44 - Alarm Status	44 - Alarm ON /Alarm OFF status	RO	-	32 bit int.
982	44 - Alarm Value	44 - Value of related alarm parameter	RO	-	32 bit float
984	45 - Alarm Timestamp	45 - Alarm time	RO	-	32 bit unix time
986	45 - Alarm ID	45 - Alarm ID	RO	-	32 bit int.
988	45 - Alarm Status	45 - Alarm ON /Alarm OFF status	RO	-	32 bit int.
990	45 - Alarm Value	45 - Value of related alarm parameter	RO	-	32 bit float
992	46 - Alarm Timestamp	46 - Alarm time	RO	-	32 bit unix time
994	46 - Alarm ID	46 - Alarm ID	RO	-	32 bit int.
996	46 - Alarm Status	46 - Alarm ON /Alarm OFF status	RO	-	32 bit int.
998	46 - Alarm Value	46 - Value of related alarm parameter	RO	-	32 bit float
1000	47 - Alarm Timestamp	47 - Alarm time	RO	-	32 bit unix time
1002	47 - Alarm ID	47 - Alarm ID	RO	-	32 bit int.
1004	47 - Alarm Status	47 - Alarm ON /Alarm OFF status	RO	-	32 bit int.
1006	47 - Alarm Value	47 - Value of related alarm parameter	RO	-	32 bit float
1008	48 - Alarm Timestamp	48 - Alarm time	RO	-	32 bit unix time
1010	48 - Alarm ID	48 - Alarm ID	RO	-	32 bit int.
1012	48 - Alarm Status	48 - Alarm ON /Alarm OFF status	RO	-	32 bit int.
1014	48 - Alarm Value	48 - Value of related alarm parameter	RO	-	32 bit float



Address	Parameter	Description	R/W	Unit	Data Type
1016	49 - Alarm Timestamp	49 - Alarm time	RO	-	32 bit unix time
1018	49 - Alarm ID	49 - Alarm ID	RO	-	32 bit int.
1020	49 - Alarm Status	49 - Alarm ON /Alarm OFF status	RO	-	32 bit int.
1022	49 - Alarm Value	49 - Value of related alarm parameter	RO	-	32 bit float
1024	50 - Alarm Timestamp	50 - Alarm time	RO	-	32 bit unix time
1026	50 - Alarm ID	50 - Alarm ID	RO	-	32 bit int.
1028	50 - Alarm Status	50 - Alarm ON /Alarm OFF status	RO	-	32 bit int.
1030	50 - Alarm Value	50 - Value of related alarm parameter	RO	-	32 bit float
<b>LAST SAVED FILE NUMBERS</b>					
1032	Hourly Archival File Nr.	Latest recorded hourly archival file number	RO	-	32 bit int.
1034	Daily Archival File Nr.	Latest recorded daily archival file number	RO	-	32 bit int.
1036	Monthly Archival File Nr.	Latest recorded monthly archival file number	RO	-	32 bit int.
<b>GENERATOR INPUT STATUS</b>					
1038	GEN INPUT	Jenerator Active/Passive Status	RO	-	32 bit int.
<b>ENERGY METERS (64 bit)</b>					
1040	T1 Imp. Active Index	Tariff 1 Import Active Index	RO	kWh	64 bit double
1044	T1 Exp. Active Index	Tariff 1 ExportActive Index	RO	kWh	64 bit double
1048	T1 Ind. Reactive Index	Tariff 1 Inductive Reactive Index	RO	kVArh	64 bit double
1052	T1 Cap. Reactive Index	Tariff 1 Capacitive Reactive Index	RO	kVArh	64 bit double

**Unix time:** Unix time is the number of seconds elapsed since midnight (00:00) Coordinated Universal Time (UTC) of January 1, 1970, not counting leaps seconds.

**NOTE:** Tariff Meters' Index Values can be read in 32 bit and/or 64bit floating point format. Mathematically, 64bit floating point representation is more accurate than 32 bit floating point format.

**e.g.**

When it is required to read "Tariff 1 Import Active Index" value, it can be received either 32 bit floating point format (modbus adr. 506) or in 64 bit floating point format (modbus adr. 1040).

If related index value is wanted to read more sensitive, 64bit versions must be selected.



### 4.5.1.2.1 Alarm Flags(RAPIDUS 232R-E)

Each bit of an alarm flag variable corresponds to 'one' alarm flag.

If any bit's value is "1", then there is alarm for that bit. On the contrary, a bit value of "1" means that there is NO alarm for that bit.

The contents of alarm flag variables are listed below.

#### Alarms 1

<u>b7</u> THDV1	<u>b6</u> I3	<u>b5</u> I2	<u>b4</u> I1	<u>b3</u> V3	<u>b2</u> V2	<u>b1</u> V1	<u>b0</u> Sic.
<u>b15</u> VLL31	<u>b14</u> VLL23	<u>b13</u> VLL12	<u>b12</u> V3 Harmonics	<u>b11</u> V2 Harmonics	<u>b10</u> V1 Harmonics	<u>b9</u> THDV3	<u>b8</u> THDV2
<u>b23</u> S1	<u>b22</u> Q3	<u>b21</u> Q2	<u>b20</u> Q1	<u>b19</u> P3	<u>b18</u> P2	<u>b17</u> P1	<u>b16</u> IN
<u>b31</u> PF3	<u>b30</u> PF2	<u>b29</u> PF1	<u>b28</u> COSØ3	<u>b27</u> COSØ2	<u>b26</u> COSØ1	<u>b25</u> S3	<u>b24</u> S2

#### Alarms 2

<u>b7</u> I2	<u>b6</u> I1	<u>b5</u> THDV3	<u>b4</u> THDV2	<u>b3</u> THDV1	<u>b2</u> F3	<u>b1</u> F2	<u>b0</u> F1
Harmonics		Harmonics					
<u>b15</u> -	<u>b14</u> -	<u>b13</u> Under Comp.	<u>b12</u> Over Comp.	<u>b11</u> Cap. Energy	<u>b10</u> Ind. Energy	<u>b9</u> Battery	<u>b8</u> I3 Harmonics
<u>b23</u> -	<u>b22</u> -	<u>b21</u> -	<u>b20</u> -	<u>b19</u> -	<u>b18</u> -	<u>b17</u> -	<u>b16</u> -
<u>b31</u> -	<u>b30</u> -	<u>b29</u> -	<u>b28</u> -	<u>b27</u> -	<u>b26</u> -	<u>b25</u> -	<u>b24</u> -



**Abbreviations used for the Alarm Flags are:**

<b>Temp.</b> : Temperature	<b>S1</b> : Phase1 Apparent Power
<b>V1</b> : Phase1 (L-N) Voltage	<b>S2</b> : Phase2 Apparent Power
<b>V2</b> : Phase2 (L-N) Voltage	<b>S3</b> : Phase3 Apparent Power
<b>V3</b> : Phase3 (L-N) Voltage	<b>CosØ1</b> : Phase1 CosØ
<b>I1</b> : Phase1 Current	<b>CosØ2</b> : Phase2 CosØ
<b>I2</b> : Phase2 Current	<b>CosØ3</b> : Phase3 CosØ
<b>I3</b> : Phase3 Current	<b>PF1</b> : Phase1 Power Factor
<b>THDV1</b> : Phase1 Total Harmonic Distortion in Voltage	<b>PF2</b> : Phase2 Power Factor
<b>THDV2</b> : Phase2 Total Harmonic Distortion in Voltage	<b>PF3</b> : Phase3 Power Factor
<b>THDV3</b> : Phase3 Total Harmonic Distortion in Voltage	<b>F1</b> : Phase1 Frequency
<b>V1 Harmonics</b> : Phase1 Voltage Harmonics	<b>F2</b> : Phase2 Frequency
<b>V2 Harmonics</b> : Phase2 Voltage Harmonics	<b>F3</b> : Phase3 Frequency
<b>V3 Harmonics</b> : Phase3 Voltage Harmonics	<b>THD11</b> : Phase1 Total Harmonic Distortion in Current
<b>VLL1</b> : Phase1-Phase2 Voltage	<b>THD12</b> : Phase2 Total Harmonic Distortion in Current
<b>VLL2</b> : Phase2-Phase3 Voltage	<b>THD13</b> : Phase3 Total Harmonic Distortion in Current
<b>VLL3</b> : Phase3-Phase1 Voltage	<b>I1 Harmonics</b> : Phase1 Current Harmonics
<b>IN</b> : Neutral Current	<b>I2 Harmonics</b> : Phase2 Current Harmonics
<b>P1</b> : Phase1 Active Power	<b>I3 Harmonics</b> : Phase3 Current Harmonics
<b>P2</b> : Phase2 Active Power	<b>Battery</b> : Battery Voltage
<b>P3</b> : Phase3 Active Power	<b>Ind. Energy</b> : Inductive Energy
<b>Q1</b> : Phase1 Reactive Power	<b>Cap. Energy</b> : Capacitive Energy
<b>Q2</b> : Phase2 Reactive Power	<b>Over Comp.</b> : Over Compensation
<b>Q3</b> : Phase3 Reactive Power	<b>Under Comp.</b> : Under Compensation

## 4.5.2 RAPIDUS Setting Parameters

Operator/programmer should use '10H - Write Multiple Registers and '06H - Write Single Register' to change settings parameters.

Operator/programmer should use '0x3H - Read Holding Registers' function to read setting parameters.

1 register -> comprises of 2 bytes.



After Rapidus setting parameters have been changed, in order for the new values to be saved in non-volatile memory; 0x0000 should be written to register 1998, and 0x0001 should be written in register 1999, within 60 seconds following the last setting change. Only after that, changes will be stored in the permanent memory.

**NOTE1:**

3 parameters given with “RO (Read Only)” in [Table 4-6](#) and [Table 4-8](#) are read-only data. They cannot be changed by the user. This data is as given below:

- Serial Number
- Firmware Version
- Compiler Version

**NOTE2:**

1998 addressed variable at the end of [Table 4-6](#) and [Table 4-8](#) are a “W (only writable)” variable.

### 4.5.2.1 Setting for RAPIDUS 231R-E

Table 4-6 Setting Parameter (Available for RAPIDUS 231R-E)

Address	Parameter	Data Type	Descript.	R/W	Unit	Low Limit	High Limit
<b>NETWORK SETTINGS</b>							
2000	Current Transf. Ratio (CTR)	32 bit float	-	R/W	-	1	5000
2002	Voltage Transf. Ratio (VTR)	32 bit float	-	R/W	-	1	5000
2004	Demand Period	32 bit int.	-	R/W	min.	1	60
<b>ENERGY SETTINGS</b>							
2006	Start of day	32 bit int.	-	R/W	hour	0	23
2008	Start of month	32 bit int.	-	R/W	-	1	28
2010	T1 kWh	32 bit float	-	R/W	kWh	0	20000000000.0
2012	T1 kWh E.	32 bit float	-	R/W	kWh	0	20000000000.0
2014	T1 kVArh I.	32 bit float	-	R/W	kVArh	0	20000000000.0
2016	T1 kVArh C.	32 bit float	-	R/W	kVArh	0	20000000000.0
<b>STEP SETTINGS</b>							
2018	Step1 power	32 bit float	-	R/W	kVArh	0	1000
2020	Step1 type	32 bit int.	S1	R/W	-	0	7
2022	Step2 power	32 bit float	-	R/W	kVArh	0	1000
2024	Step2 type	32 bit int.	S1	R/W	-	0	7
2026	Step3 power	32 bit float	-	R/W	kVArh	0	1000
2028	Step3 type	32 bit int.	S1	R/W	-	0	7
2030	Step4 power	32 bit float	-	R/W	kVArh	0	1000
2032	Step4 type	32 bit int.	S1	R/W	-	0	7
2034	Step5 power	32 bit float	-	R/W	kVArh	0	1000
2036	Step5 type	32 bit int.	S1	R/W	-	0	7
2038	Step6 power	32 bit float	-	R/W	kVArh	0	1000
2040	Step6 type	32 bit int.	S1	R/W	-	0	7
2042	Step7 power	32 bit float	-	R/W	kVArh	0	1000
2044	Step7 type	32 bit int.	S1	R/W	-	0	7
2046	Step8 power	32 bit float	-	R/W	kVArh	0	1000
2048	Step8 type	32 bit int.	S1	R/W	-	0	7
2050	Step9 power	32 bit float	-	R/W	kVArh	0	1000
2052	Step9 type	32 bit int.	S1	R/W	-	0	7

Address	Parameter	Data Type	Descript.	R/W	Unit	Low Limit	High Limit
2054	Step10 power	32 bit float	-	R/W	kVArh	0	1000
2056	Step10 type	32 bit int.	S1	R/W	-	0	7
2058	Step11 power	32 bit float	-	R/W	kVArh	0	1000
2060	Step11 type	32 bit int.	S1	R/W	-	0	7
2062	Step12 power	32 bit float	-	R/W	kVArh	0	1000
2064	Step12 type	32 bit int.	S1	R/W	-	0	7
2066	Bank structure	32 bit int.	S2	R/W	-	0	8
2068	Bank power	32 bit float	-	R/W	kVArh	0	1000
2070	Bank count	32 bit int.	-	R/W	-	0	12
2072	Discharge time	32 bit int.	-	R/W	sec	3	1000
<b>COMPENSATION SETTINGS</b>							
2074	Steps	32 bit int.	S3	R/W	-	0	2
2076	Program	32 bit int.	S4	R/W	-	0	4
2078	Target 1	32 bit float	-	R/W	-	-0.800	0.800
2080	Target 2	32 bit float	-	R/W	-	0.000	1.000
2082	Target low limit	32 bit float	-	R/W	-	0.000	0.200
2084	Target high limit	32 bit float	-	R/W	-	0.000	0.200
2086	Activation time	32 bit int.	-	R/W	sec	1	600
2088	Deactivation time	32 bit int.	-	R/W	sec	1	600
2090	Shift angle	32 bit float	-	R/W	-	-45	45
2092	Fixed steps	32 bit int.	S10	R/W	-	0	3
2094	Averaging time	32 bit int.	S14	R/W	-	0	7
<b>COMMUNICATION SETTINGS</b>							
2096	BaudRate	32 bit int.	S6	R/W	-	0	6
2098	Slaveld	32 bit int.	-	R/W	-	1	247
<b>ALARM SETTINGS</b>							
<b>VOLTAGE (L-N) ALARM</b>							
2100	Alarm relay	32 bit int.	S5	R/W	-	0	2
2102	Low limit	32 bit float	-	R/W	V	0	1500000
2104	High limit	32 bit float	-	R/W	V	0	1500000
2106	Alarm time	32 bit int.	-	R/W	sec	0	600
2108	Hysteresis	32 bit float	-	R/W	%	0	20
<b>VOLTAGE (L-L) ALARM</b>							
2110	Alarm relay	32 bit int.	S5	R/W	-	0	2
2112	Low limit	32 bit float	-	R/W	V	0	2600000
2114	High limit	32 bit float	-	R/W	V	0	2600000
2116	Alarm time	32 bit int.	-	R/W	sec	0	600
2118	Hysteresis	32 bit float	-	R/W	%	0	20
<b>CURRENT ALARM</b>							
2120	Alarm relay	32 bit int.	S5	R/W	-	0	2
2122	Low limit	32 bit float	-	R/W	A	0	30000
2124	High limit	32 bit float	-	R/W	A	0	30000
2126	Alarm time	32 bit int.	-	R/W	sec	0	600
2128	Hysteresis	32 bit float	-	R/W	%	0	20

Address	Parameter	Data Type	Descript.	R/W	Unit	Low Limit	High Limit
<b>ACTIVE POWER ALARM</b>							
2130	Alarm relay	32 bit int.	S5	R/W	-	0	2
2132	Low limit	32 bit float	-	R/W	W	-1,00E+10	1,00E+10
2134	High limit	32 bit float	-	R/W	W	-1,00E+10	1,00E+10
2136	Alarm time	32 bit int.	-	R/W	sec	0	600
2138	Hysteresis	32 bit float	-	R/W	%	0	20
<b>REACTIVE POWER ALARM</b>							
2140	Alarm relay	32 bit int.	S5	R/W	-	0	2
2142	Low limit	32 bit float	-	R/W	VAr	-1,00E+10	1,00E+10
2144	High limit	32 bit float	-	R/W	VAr	-1,00E+10	1,00E+10
2146	Alarm time	32 bit int.	-	R/W	sec	0	600
2148	Hysteresis	32 bit float	-	R/W	%	0	20
<b>APPARENT POWER ALARM</b>							
2150	Alarm relay	32 bit int.	S5	R/W	-	0	2
2152	Low limit	32 bit float	-	R/W	A	0	30000
2154	High limit	32 bit float	-	R/W	A	0	30000
2156	Alarm time	32 bit int.	-	R/W	sec	0	600
2158	Hysteresis	32 bit float	-	R/W	%	0	20
<b>NEUTRAL CURRENT ALARM</b>							
2160	Alarm relay	32 bit int.	S5	R/W	-	0	2
2162	Low limit	32 bit float	-	R/W	-	0	1
2164	High limit	32 bit float	-	R/W	-	0	1
2166	Alarm time	32 bit int.	-	R/W	sec	0	600
2168	Hysteresis	32 bit float	-	R/W	%	0	20
<b>POWER FACTOR ALARM</b>							
2170	Alarm relay	32 bit int.	S5	R/W	-	0	2
2172	Low limit	32 bit float	-	R/W	-	0	1
2174	High limit	32 bit float	-	R/W	-	0	1
2176	Alarm time	32 bit int.	-	R/W	sec	0	600
2178	Hysteresis	32 bit float	-	R/W	%	0	20
<b>COSØ ALARM</b>							
2180	Alarm relay	32 bit int.	S5	R/W	-	0	2
2182	Low limit	32 bit float	-	R/W	-	0	1
2184	High limit	32 bit float	-	R/W	-	0	1
2186	Alarm time	32 bit int.	-	R/W	sec	0	600
2188	Hysteresis	32 bit float	-	R/W	%	0	20
<b>FREQUENCY ALARM</b>							
2190	Alarm relay	32 bit int.	S5	R/W	-	0	2
2192	Low limit	32 bit float	-	R/W	Hz	35	70
2194	High limit	32 bit float	-	R/W	Hz	35	70
2196	Alarm time	32 bit int.	-	R/W	sec	0	600
2198	Hysteresis	32 bit float	-	R/W	%	0	20

Address	Parameter	Data Type	Descript.	R/W	Unit	Low Limit	High Limit
<b>TEMPERATURE ALARM</b>							
2200	Alarm relay	32 bit int.	S5	R/W	-	0	2
2202	Low limit	32 bit float	-	R/W	°C	-20	80
2204	High limit	32 bit float	-	R/W	°C	-20	80
2206	Alarm time	32 bit int.	-	R/W	sec	0	600
2208	Hysteresis	32 bit float	-	R/W	%	0	20
<b>VOLTAGE HARMONICS ALARM</b>							
2210	Alarm relay	32 bit int.	S5	R/W	-	0	2
2212	THD_High limit	32 bit float	-	R/W	%	0	100
2214	High limit harmonic 3	32 bit float	-	R/W	%	0	100
2216	High limit harmonic 5	32 bit float	-	R/W	%	0	100
2218	High limit harmonic 7	32 bit float	-	R/W	%	0	100
2220	High limit harmonic 9	32 bit float	-	R/W	%	0	100
2222	High limit harmonic 11	32 bit float	-	R/W	%	0	100
2224	High limit harmonic 13	32 bit float	-	R/W	%	0	100
2226	High limit harmonic 15	32 bit float	-	R/W	%	0	100
2228	High limit harmonic 17	32 bit float	-	R/W	%	0	100
2230	High limit harmonic 19	32 bit float	-	R/W	%	0	100
2232	High limit harmonic 21	32 bit float	-	R/W	%	0	100
2234	Alarm time	32 bit int.	-	R/W	sec	0	600
<b>CURRENT HARMONICS ALARM</b>							
2236	Alarm relay	32 bit int.	S5	R/W	%	0	2
2238	THD_High limit	32 bit float	-	R/W	%	0	100
2240	High limit harmonic 3	32 bit float	-	R/W	%	0	100
2242	High limit harmonic 5	32 bit float	-	R/W	%	0	100
2244	High limit harmonic 7	32 bit float	-	R/W	%	0	100
2246	High limit harmonic 9	32 bit float	-	R/W	%	0	100
2248	High limit harmonic 11	32 bit float	-	R/W	%	0	100
2250	High limit harmonic 13	32 bit float	-	R/W	%	0	100
2252	High limit harmonic 15	32 bit float	-	R/W	%	0	100
2254	High limit harmonic 17	32 bit float	-	R/W	%	0	100
2256	High limit harmonic 19	32 bit float	-	R/W	%	0	100
2258	High limit harmonic 21	32 bit float	-	R/W	%	0	100
2260	Alarm time	32 bit int.	-	R/W	sec	0	600
<b>INDUCTIVE ENERGY ALARM (Qind./P)</b>							
2262	High limit	32 bit float	-	R/W	%	0	40
2264	Alarm relay	32 bit int.	S5	R/W	-	0	2
<b>CAPACITIVE ENERGY ALARM (Qcap./P)</b>							
2266	High limit	32 bit float	-	R/W	%	0	40
2268	Alarm relay	32 bit int.	S5	R/W	-	0	2
<b>STEP ALARM</b>							
2270	Low limit	32 bit float	-	R/W	%	20	100

Address	Parameter	Data Type	Descript.	R/W	Unit	Low Limit	High Limit
<b>MODE INPUT (DAY/NIGHT or GENERATOR)</b>							
2272	Mode Input	32 bit int.	S11	R/W	-	0	2
<b>CONNECTION LEARN SETTINGS</b>							
2274	Learn conn. at start	32 bit int.	S13	R/W	-	0	1
2276	Learn conn. step number	32 bit int.	-	R/W	-	1	12
2278	Learn conn. retry timer	32 bit int.	-	R/W	sec	5	60
2280	Learn conn. retry count	32 bit int.	-	R/W	-	1	20
<b>STEP LEARN SETTINGS</b>							
2282	Learn steps at start	32 bit int.	S13	R/W	-	0	1
<b>DEVICE SETTINGS</b>							
2284	Language	32 bit int.	S7	R/W	-	0	1
2286	Contrast	32 bit int.	S8	R/W	-	0	8
2288	Password	32 bit int.	-	R/W	-	1	9999
2290	Password protection	32 bit int.	S12	R/W	-	1	9999
2292	DisplayOn	32 bit int.	S9	R/W	-	0	1
2294	DisplayTime	32 bit int.	-	R/W	sec	10	600
2296	SerialNumber	32 bit int.	-	RO	-	0	0
2298	FirmwareVer	32 bit float	-	RO	-	0	0
2300	Order Number	32 bit float	-	RO	-	0	0
2302	ConfigName	String	-	R/W	-	0	0
2314	DeviceName	String	-	R/W	-	0	0



Table 4-7 String List (Available for RAPIDUS 231R-E)

SL1	SL2	SL3	SL4	SL5	SL6	SL6
0)C	0-)1 - 1 - 1 - 1	0-Entered	0-Rapidus	0-Off	0)2400	0)Türkçe
1)L	1-)1 - 1 - 2 - 2	1-Predefined	1-Asc. Sequential	1-Relay1	1)4800	1)English
2)C1	2-)1 - 2 - 2 - 4	2-DCM	2-Des. sequential	2-Relay2	2)9600	2)Русский
3)C2	3-)1 - 2 - 3 - 3		3-Linear		3)19200	
4)C3	4-)1 - 2 - 4 - 4		4-Circular		4)38400	
5)L1	5-)1 - 1 - 2 - 4				5)57600	
6)L2	6-)1 - 2 - 3 - 4				6)115200	
7)L3	7-)1 - 2 - 4 - 8					
8)C1-2	8-)1 - 1 - 2 - 3					
9)C2-3						
10)L3-1						
11)L1-2						
12)L2-3						
13)L3-1						

S8	S9	S10	S11	S12	S13	S14
0-Level -4	0-Continuous	0-None	0-Off	0-Inactive	0-Off	0-Off
1-Level -3	1-Time dependent	1-Stage 1	1-Night/Day	1-Active	1-On	1-5 sec.
2-Level -2		2-Stage 1 and 2	2-Generator			2-10 sec.
3-Level -1		3-Stage 1, 2 and 3				3-20 sec.
4-Level 0						4-30 sec.
5-Level 1						5-40 sec.
6-Level 2						6-50 sec.
7-Level 3						7-60 sec.
8-Level 4						

#### 4.5.2.2 Setting Parameters for RAPIDUS 232R-E

Table 4-8 Setting Parameter (Available for RAPIDUS 232R-E)

Address	Parameter	Data Type	Descript.	R/W	Unit	Low Limit	High Limit
<b>NETWORK SETTINGS</b>							
2000	Current Transf. Ratio (CTR)	32 bit float	-	R/W	-	1	5000
2002	Voltage Transf. Ratio (VTR)	32 bit float	-	R/W	-	1	5000
2004	Demand Period	32 bit int.	-	R/W	min.	1	60
<b>ENERGY SETTINGS</b>							
2006	Start of day	32 bit int.	-	R/W	hour	0	23
2008	Start of month	32 bit int.	-	R/W	-	1	28
2010	T1 kWh	32 bit float	-	R/W	kWh	0	20000000000.0
2012	T1 kWh E.	32 bit float	-	R/W	kWh	0	20000000000.0
2014	T1 kVArh I.	32 bit float	-	R/W	kVArh	0	20000000000.0
2016	T1 kVArh C.	32 bit float	-	R/W	kVArh	0	20000000000.0
<b>STEP SETTINGS</b>							
2018	Step1 power	32 bit float	-	R/W	kVArh	0	1000
2020	Step1 type	32 bit int.	S1	R/W	-	0	7
2022	Step2 power	32 bit float	-	R/W	kVArh	0	1000

Address	Parameter	Data Type	Descript.	R/W	Unit	Low Limit	High Limit
2024	Step2 type	32 bit int.	S1	R/W	-	0	7
2026	Step3 power	32 bit float	-	R/W	kVArh	0	1000
2028	Step3 type	32 bit int.	S1	R/W	-	0	7
2030	Step4 power	32 bit float	-	R/W	kVArh	0	1000
2032	Step4 type	32 bit int.	S1	R/W	-	0	7
2034	Step5 power	32 bit float	-	R/W	kVArh	0	1000
2036	Step5 type	32 bit int.	S1	R/W	-	0	7
2038	Step6 power	32 bit float	-	R/W	kVArh	0	1000
2040	Step6 type	32 bit int.	S1	R/W	-	0	7
2042	Step7 power	32 bit float	-	R/W	kVArh	0	1000
2044	Step7 type	32 bit int.	S1	R/W	-	0	7
2046	Step8 power	32 bit float	-	R/W	kVArh	0	1000
2048	Step8 type	32 bit int.	S1	R/W	-	0	7
2050	Step9 power	32 bit float	-	R/W	kVArh	0	1000
2052	Step9 type	32 bit int.	S1	R/W	-	0	7
2054	Step10 power	32 bit float	-	R/W	kVArh	0	1000
2056	Step10 type	32 bit int.	S1	R/W	-	0	7
2058	Step11 power	32 bit float	-	R/W	kVArh	0	1000
2060	Step11 type	32 bit int.	S1	R/W	-	0	7
2062	Step12 power	32 bit float	-	R/W	kVArh	0	1000
2064	Step12 type	32 bit int.	S1	R/W	-	0	7
2066	Step13 power	32 bit float	-	R/W	kVArh	0	1000
2068	Step13 type	32 bit int.	S1	R/W	-	0	7
2070	Step14 power	32 bit float	-	R/W	kVArh	0	1000
2072	Step14 type	32 bit int.	S1	R/W	-	0	7
2074	Step15 power	32 bit float	-	R/W	kVArh	0	1000
2076	Step15 type	32 bit int.	S1	R/W	-	0	7
2078	Step16 power	32 bit float	-	R/W	kVArh	0	1000
2080	Step16 type	32 bit int.	S1	R/W	-	0	7
2082	Step17 power	32 bit float	-	R/W	kVArh	0	1000
2084	Step17 type	32 bit int.	S1	R/W	-	0	7
2086	Step18 power	32 bit float	-	R/W	kVArh	0	1000
2088	Step18 type	32 bit int.	S1	R/W	-	0	7
2090	Step19 power	32 bit float	-	R/W	kVArh	0	1000
2092	Step19 type	32 bit int.	S1	R/W	-	0	7
2094	Step20 power	32 bit float	-	R/W	kVArh	0	1000
2096	Step20 type	32 bit int.	S1	R/W	-	0	7
2098	Step21 power	32 bit float	-	R/W	kVArh	0	1000
2100	Step21 type	32 bit int.	S1	R/W	-	0	7
2102	Step22 power	32 bit float	-	R/W	kVArh	0	1000
2104	Step22 type	32 bit int.	S1	R/W	-	0	7
2106	Step23 power	32 bit float	-	R/W	kVArh	0	1000
2108	Step23 type	32 bit int.	S1	R/W	-	0	7
2110	Step24 power	32 bit float	-	R/W	kVArh	0	1000
2112	Step24 type	32 bit int.	S1	R/W	-	0	7

Address	Parameter	Data Type	Descript.	R/W	Unit	Low Limit	High Limit
2114	Bank structure	32 bit int.	S2	R/W	-	0	8
2116	Bank power	32 bit float	-	R/W	kVArh	0	1000
2118	Bank count	32 bit int.	-	R/W	-	0	24
2120	Discharge time	32 bit int.	-	R/W	sec	3	1000
<b>COMPENSATION SETTINGS</b>							
2122	Steps	32 bit int.	S3	R/W	-	0	1
2124	Program	32 bit int.	S4	R/W	-	0	4
2126	Target 1	32 bit float	-	R/W	-	-0.800	0.800
2128	Target 2	32 bit float	-	R/W	-	0.000	1.000
2130	Target low limit	32 bit float	-	R/W	-	0.000	0.200
2132	Target high limit	32 bit float	-	R/W	-	0.000	0.200
2134	Activation time	32 bit int.	-	R/W	sec	1	600
2136	Deactivation time	32 bit int.	-	R/W	sec	1	600
2138	Shift angle	32 bit float	-	R/W	-	-45	45
2140	Fixed steps	32 bit int.	S10	R/W	-	0	3
2142	Averaging time	32 bit int.	S14	R/W	-	0	7
<b>COMMUNICATION SETTINGS</b>							
2144	BaudRate	32 bit int.	S6	R/W	-	0	6
2146	Slaveld	32 bit int.	-	R/W	-	1	247
<b>ALARM SETTINGS</b>							
<b>VOLTAGE (L-N) ALARM</b>							
2148	Alarm relay	32 bit int.	S5	R/W	-	0	2
2150	Low limit	32 bit float	-	R/W	V	0	1500000
2152	High limit	32 bit float	-	R/W	V	0	1500000
2154	Alarm time	32 bit int.	-	R/W	sec	0	600
2156	Hysteresis	32 bit float	-	R/W	%	0	20
<b>VOLTAGE (L-L) ALARM</b>							
2158	Alarm relay	32 bit int.	S5	R/W	-	0	2
2160	Low limit	32 bit float	-	R/W	V	0	2600000
2162	High limit	32 bit float	-	R/W	V	0	2600000
2164	Alarm time	32 bit int.	-	R/W	sec	0	600
2166	Hysteresis	32 bit float	-	R/W	%	0	20
<b>CURRENT ALARM</b>							
2168	Alarm relay	32 bit int.	S5	R/W	-	0	2
2170	Low limit	32 bit float	-	R/W	A	0	30000
2172	High limit	32 bit float	-	R/W	A	0	30000
2174	Alarm time	32 bit int.	-	R/W	sec	0	600
2176	Hysteresis	32 bit float	-	R/W	%	0	20
<b>ACTIVE POWER ALARM</b>							
2178	Alarm relay	32 bit int.	S5	R/W	-	0	2
2180	Low limit	32 bit float	-	R/W	W	-1E+10	10000000000
2182	High limit	32 bit float	-	R/W	W	-1E+10	10000000000
2184	Alarm time	32 bit int.	-	R/W	sec	0	600
2186	Hysteresis	32 bit float	-	R/W	%	0	20

Address	Parameter	Data Type	Descript.	R/W	Unit	Low Limit	High Limit
<b>REACTIVE POWER ALARM</b>							
2188	Alarm relay	32 bit int.	S5	R/W	-	0	2
2190	Low limit	32 bit float	-	R/W	VAr	-1E+10	10000000000
2192	High limit	32 bit float	-	R/W	VAr	-1E+10	10000000000
2194	Alarm time	32 bit int.	-	R/W	sec	0	600
2196	Hysteresis	32 bit float	-	R/W	%	0	20
<b>APPARENT POWER ALARM</b>							
2198	Alarm relay	32 bit int.	S5	R/W	-	0	2
2200	Low limit	32 bit float	-	R/W	A	0	30000
2202	High limit	32 bit float	-	R/W	A	0	30000
2204	Alarm time	32 bit int.	-	R/W	sec	0	600
2206	Hysteresis	32 bit float	-	R/W	%	0	20
<b>NEUTRAL CURRENT ALARM</b>							
2208	Alarm relay	32 bit int.	S5	R/W	-	0	2
2210	Low limit	32 bit float	-	R/W	-	0	1
2212	High limit	32 bit float	-	R/W	-	0	1
2214	Alarm time	32 bit int.	-	R/W	sec	0	600
2216	Hysteresis	32 bit float	-	R/W	%	0	20
<b>POWER FACTOR ALARM</b>							
2218	Alarm relay	32 bit int.	S5	R/W	-	0	2
2220	Low limit	32 bit float	-	R/W	-	0	1
2222	High limit	32 bit float	-	R/W	-	0	1
2224	Alarm time	32 bit int.	-	R/W	sec	0	600
2226	Hysteresis	32 bit float	-	R/W	%	0	20
<b>COSØ ALARM</b>							
2228	Alarm relay	32 bit int.	S5	R/W	-	0	2
2230	Low limit	32 bit float	-	R/W	-	0	1
2232	High limit	32 bit float	-	R/W	-	0	1
2234	Alarm time	32 bit int.	-	R/W	sec	0	600
2236	Hysteresis	32 bit float	-	R/W	%	0	20
<b>FREQUENCY ALARM</b>							
2238	Alarm relay	32 bit int.	S5	R/W	-	0	2
2240	Low limit	32 bit float	-	R/W	Hz	35	70
2242	High limit	32 bit float	-	R/W	Hz	35	70
2244	Alarm time	32 bit int.	-	R/W	sec	0	600
2246	Hysteresis	32 bit float	-	R/W	%	0	20
<b>TEMPERATURE ALARM</b>							
2248	Alarm relay	32 bit int.	S5	R/W	-	0	2
2250	Low limit	32 bit float	-	R/W	°C	-20	80
2252	High limit	32 bit float	-	R/W	°C	-20	80
2254	Alarm time	32 bit int.	-	R/W	sec	0	600
2256	Hysteresis	32 bit float	-	R/W	%	0	20

Address	Parameter	Data Type	Descript.	R/W	Unit	Low Limit	High Limit
<b>VOLTAGE HARMONICS ALARM</b>							
2258	Alarm relay	32 bit int.	S5	R/W	-	0	2
2260	THD_High limit	32 bit float	-	R/W	%	0	100
2262	High limit harmonic 3	32 bit float	-	R/W	%	0	100
2264	High limit harmonic 5	32 bit float	-	R/W	%	0	100
2266	High limit harmonic 7	32 bit float	-	R/W	%	0	100
2268	High limit harmonic 9	32 bit float	-	R/W	%	0	100
2270	High limit harmonic 11	32 bit float	-	R/W	%	0	100
2272	High limit harmonic 13	32 bit float	-	R/W	%	0	100
2274	High limit harmonic 15	32 bit float	-	R/W	%	0	100
2276	High limit harmonic 17	32 bit float	-	R/W	%	0	100
2278	High limit harmonic 19	32 bit float	-	R/W	%	0	100
2280	High limit harmonic 21	32 bit float	-	R/W	%	0	100
2282	Alarm time	32 bit int.	-	R/W	sec	0	600
<b>CURRENT HARMONICS ALARM</b>							
2284	Alarm relay	32 bit int.	S5	R/W	%	0	2
2286	THD_High limit	32 bit float	-	R/W	%	0	100
2288	High limit harmonic 3	32 bit float	-	R/W	%	0	100
2290	High limit harmonic 5	32 bit float	-	R/W	%	0	100
2292	High limit harmonic 7	32 bit float	-	R/W	%	0	100
2294	High limit harmonic 9	32 bit float	-	R/W	%	0	100
2296	High limit harmonic 11	32 bit float	-	R/W	%	0	100
2298	High limit harmonic 13	32 bit float	-	R/W	%	0	100
2300	High limit harmonic 15	32 bit float	-	R/W	%	0	100
2302	High limit harmonic 17	32 bit float	-	R/W	%	0	100
2304	High limit harmonic 19	32 bit float	-	R/W	%	0	100
2306	High limit harmonic 21	32 bit float	-	R/W	%	0	100
2308	Alarm time	32 bit int.	-	R/W	sec	0	600
<b>INDUCTIVE ENERGY ALARM (Qind./P)</b>							
2310	High limit	32 bit float	-	R/W	%	0	40
2312	Alarm relay	32 bit int.	S5	R/W	-	0	2
<b>CAPACITIVE ENERGY ALARM (Qcap./P)</b>							
2314	High limit	32 bit float	-	R/W	%	0	40
2316	Alarm relay	32 bit int.	S5	R/W	-	0	2

Address	Parameter	Data Type	Descript.	R/W	Unit	Low Limit	High Limit
<b>MODE INPUT (DAY/NIGHT or GENERATOR)</b>							
2318	Mode Input	32 bit int.	S11	R/W	-	0	2
<b>CONNECTION LEARN SETTINGS</b>							
2320	Learn conn. at start	32 bit int.	S13	R/W	-	0	1
2322	Learn conn. step number	32 bit int.	-	R/W	-	1	12
2324	Learn conn. retry timer	32 bit int.	-	R/W	sec	5	60
2326	Learn conn. retry count	32 bit int.	-	R/W	-	1	20
<b>STEP LEARN SETTINGS</b>							
2328	Learn steps at start	32 bit int.	S13	R/W	-	0	1
<b>DEVICE SETTINGS</b>							
2330	Language	32 bit int.	S7	R/W	-	0	1
2332	Contrast	32 bit int.	S8	R/W	-	0	8
2334	Password	32 bit int.	-	R/W	-	1	9999
2336	Password protection	32 bit int.	S12	R/W	-	0	1
2338	DisplayOn	32 bit int.	S9	R/W	-	0	1
2340	DisplayTime	32 bit int.	-	R/W	sec	10	600
2342	SerialNumber	32 bit int.	-	RO	-	0	0
2344	FirmwareVer	32 bit float	-	RO	-	0	0
2346	Order Number	32 bit float	-	RO	-	0	0
2348	ConfigName	String	-	R/W	-	0	0
2360	DeviceName	String	-	R/W	-	0	0

Table 4-9 String List (Available for RAPIDUS 232R-E)

SL1	SL2	SL3	SL4	SL5	SL6	SL6
0)C	0-)1 - 1 - 1 - 1	0-Entered	0-Rapidus	0-Off	0)2400	0)Türkçe
1)L	1-)1 - 1 - 2 - 2	1-Predefined	1-Asc. Sequential	1-Relay1	1)4800	1)English
2)C1	2-)1 - 2 - 2 - 4		2-Des. sequential	2-Relay2	2)9600	2)Русский
3)C2	3-)1 - 2 - 3 - 3		3-Linear		3)19200	
4)C3	4-)1 - 2 - 4 - 4		4-Circular		4)38400	
5)L1	5-)1 - 1 - 2 - 4				5)57600	
6)L2	6-)1 - 2 - 3 - 4				6)115200	
7)L3	7-)1 - 2 - 4 - 8					
8)C1-2	8-)1 - 1 - 2 - 3					
9)C2-3						
10)L3-1						
11)L1-2						
12)L2-3						
13)L3-1						

S8	S9	S10	S11	S12	S13	S14
0-Level -4	0-Continuous	0-None	0-Off	0-Inactive	0-Off	0-Off
1-Level -3	1-Time	1-Stage 1	1-Night/Day	1-Active	1-On	1-5 sec.
2-Level -2	dependent	2-Stage 1 and 2	2-Generator			2-10 sec.
3-Level -1		3-Stage 1, 2				3-20 sec.
4-Level 0		and 3				4-30 sec.
5-Level 1						5-40 sec.
6-Level 2						6-50 sec.
7-Level 3						7-60 sec.
8-Level 4						

**EXAMPLE:**

If slave ID is assigned as 157;

<b>Request</b>		<b>RAPIDUS Response</b>	
Slave ID	01h	Slave ID	01h
Function code	10h	Function code	10h
Starting address (high)	08h	Starting address (high)	08h
Starting address (low)	26h	Starting address (low)	26h
Number of registers (high)	00h	Number of registers (high)	00h
Number of registers (low)	02h	Number of registers (low)	02h
Number of bytes	04h	CRC (high)	A2h
Register value (high)	00h	CRC (low)	63h
Register value (low)	00h		
Register value (high)	00h		
Register value (low)	9Dh		
CRC (high)	D7h		
CRC (low)	F4h		



### 4.5.3 ARCHIVE (HISTORY) RECORDS

RAPIDUS archive records consist of blocks having 68 parameters. Each parameter inside the archive block is a 32 bit length variable. Archive data block is as shown in Table 4-10.

The programmer will access archive by implementing “0x14 - Read File Record” function. “0x14 - Read File Record” function accesses the data with “file numbers”.

For RAPIDUS,

File numbers 1 – 1920 are used to access HOURLY data.

File numbers 5001- 5240 are used to access DAILY data.

File numbers 10001-10036 are used to access MONTHLY data.

- The last saved file number in the hourly data memory for RAPIDUS 231R-E; can be accessed from 984 modbus addressed parameter (Refer to Table 4-4).
- The last saved file number in the hourly data memory for RAPIDUS 232R-E; can be accessed from 1032 modbus addressed parameter (Refer to Table 4-5).
  
- The last saved file number in the daily data memory for RAPIDUS 231R-E; can be accessed from 986 modbus addressed parameter (Refer to Table 4-4).
- The last saved file number in the daily data memory for RAPIDUS 232R-E; can be accessed from 1034 modbus addressed parameter (Refer to Table 4-5).
  
- The last saved file number in the monthly data memory for RAPIDUS 231R-E; can be accessed from 988 modbus addressed parameter (Refer to Table 4-4).
- The last saved file number in the monthly data memory for RAPIDUS 232R-E; can be accessed from 1036 modbus addressed parameter (Refer to Table 4-5).

Table 4-10 Archive (History) Record Table

Item No.	History Records	Variable Type
1	Time Info (Timestamp)	32 bit int.
2	L1 average voltage value (V ave.)	32 bit float
3	L1 minimum voltage value (V1 min.)	32 bit float
4	L1 maximum voltage value (V1 max.)	32 bit float
5	L1 average current value (I1 ave.)	32 bit float
6	L1 minimum current value (I1 min.)	32 bit float
7	L1 maximum current value (I1 max.)	32 bit float
8	L1 average active power value (P1 ave.)	32 bit float
9	L1 minimum active power value (P1 min.)	32 bit float
10	L1 maximum active power value (P1 max.)	32 bit float
11	L1 average reactive power value (Q1 ave.)	32 bit float
12	L1 minimum reactive power value (Q1 min.)	32 bit float
13	L1 maximum reactive power value (Q1 max..)	32 bit float
14	L1 average apparent power value (S1 ave.)	32 bit float
15	L1 minimum apparent power value (S1 min.)	32 bit float
16	L1 maximum apparent power value (S1 max.)	32 bit float





Item No.	History Records	Variable Type
17	L1 average $\cos\phi$ value ( $\cos\phi_1$ ave.)	32 bit float
18	L1 average PF value (PF1 ave.)	32 bit float
19	L2 average voltage value (V2 ave.)	32 bit float
20	L2 minimum voltage value(V2 min.)	32 bit float
21	L2 maximum voltage value(V2 max.)	32 bit float
22	L2 average current value (I2 ave.)	32 bit float
23	L2 minimum current value (I2 min.)	32 bit float
24	L2 maximum current value (I2 max.)	32 bit float
25	L2 average active power value (P2 ave.)	32 bit float
26	L2 minimum active power value (P2 min.)	32 bit float
27	L2 maximum active power value (P2 max.)	32 bit float
28	L2 average reactive power value (Q2 ave.)	32 bit float
29	L2 minimum reactive power value (Q2 min.)	32 bit float
30	L2 maximum reactive power value (Q2 max..)	32 bit float
31	L2 average apparent power value (S2 ave.)	32 bit float
32	L2 minimum apparent power value (S2 min.)	32 bit float
33	L2 maximum apparent power value (S2 max.)	32 bit float
34	L2 average $\cos\phi$ value ( $\cos\phi_2$ ave.)	32 bit float
35	L2 average PF value (PF2 ave.)	32 bit float
36	L3 average voltage value (V3 ave.)	32 bit float
37	L3 minimum voltage value (V3 min.)	32 bit float
38	L3 maximum voltage value (V3 max.)	32 bit float
39	L3 average current value (I3 ave.)	32 bit float
40	L3 minimum current value (I3 min.)	32 bit float
41	L3 maximum current value (I3 max.)	32 bit float
42	L3 average active power value (P3 ave.)	32 bit float
43	L3 minimum active power value (P3 min.)	32 bit float
44	L3 maximum active power value (P3 max.)	32 bit float
45	L3 average reactive power value (Q3 ave.)	32 bit float
46	L3 minimum reactive power value (Q3 min.)	32 bit float
47	L3 maximum reactive power value (Q3 max..)	32 bit float
48	L3 average apparent power value (S3 ave.)	32 bit float
49	L3 minimum apparent power value (S3 min.)	32 bit float
50	L3 maximum apparent power value (S3 max.)	32 bit float
51	L3 average $\cos\phi$ value ( $\cos\phi_3$ ave.)	32 bit float
52	L3 average PF value (PF3 ave.)	32 bit float
53	V12 voltage average value (V12 ave.)	32 bit float
54	V12 voltage minimum value (V12 min.)	32 bit float
55	V12 voltage maximum value (V12 max.)	32 bit float
56	V23 voltage average value (V23 ave.)	32 bit float
57	V23 voltage minimum value (V23 min.)	32 bit float
58	V23 voltage maximum value (V23 max.)	32 bit float



Item No.	History Records	Variable Type
59	V31 voltage average value (V31 ave.)	32 bit float
60	V31 voltage minimum value (V31 min.)	32 bit float
61	V31 voltage maximum value (V31 max.)	32 bit float
62	L1 average frequency value (F1 ave.)	32 bit float
63	L1 minimum frequency value (F1 min.)	32 bit float
64	L1 maximum frequency value (F1 max.)	32 bit float
65	T1 meters consumed-imp. active energy value (T1 kWh)	32 bit float
66	T1 meters generated-exp. active energy value (T1 kWh E.)	32 bit float
67	T1 meters inductive reactive energy value	32 bit float
68	T1 meters capacitive reactive energy value	32 bit float

### 4.5.3.1 Hourly archive data

The smallest and largest instantaneous values measured during one hour period, are saved as minimum and maximum values. Likewise, average values of measurements, which were taken in one hour period, are saved as average values.

14h function operates with file numbers. File numbers between 1 – 1920 are used for HOURLY data.

Rapidus has a memory that is reserved for hourly files. It can keep totally 1920 hourly files.

Assume that, reserved memory for hourly files are filled completely. In this case, the last saved file number will be “1920” and user can access this number with querying 984th modbus address for RAPIDUS 231R-E (Refer to table 4-4). and 1032nd modbus address for RAPIDUS 232R-E (Refer to table 4-5).

Example for upper case;

1st file memory=> Hourly Data Record-1
2nd file memory=> Hourly Data Record-2
3rd file memory=> Hourly Data Record-3
.
.
.
19th file memory=> Hourly Data Record-1919
20th file memory=> Hourly Data Record-1920

If there is no enough memory for one more hourly data, the oldest record is deleted and the latest record is saved to first file memory. In this case, the last saved file number will be “1”.

1st file memory=> Hourly Data Record-1921
2nd file memory=> Hourly Data Record-2
3rd file memory=> Hourly Data Record-3
.
.
.
19th file memory=> Hourly Data Record-1919
20th file memory=> Hourly Data Record-1920

When one more hourly record is come, the last saved file number will be “2”.  
Example of upper case;

1st file memory=> Hourly Data Record-1921
2nd file memory=> Hourly Data Record-1922
3rd file memory=> Hourly Data Record-3
.
.
.
19th file memory=> Hourly Data Record-1919
20th file memory=> Hourly Data Record-1920

Briefly, when hourly memory of Rapidus is filled completely, oldest record is deleted and new record is saved in the deleted record's memory.

The 'last saved file number' inside the hourly memory can be accessed from the 32-bit parameter starting from Modbus address 1360 (Refer to table 4-4).

**EXAMPLE:**

Assume that a programmer will try to access a RAPIDUS with a slave ID number 1. Assume also that the last saved hourly file number of this device is 17. In this case, data request and RAPIDUS response will be as follows:

Query	
Slave ID	0x01
Function code	0x14
Byte Counts	0x07
Sub-req. 1 reference type	0x06
Sub-req. 1 file number HI	0x00
Sub-req. 1 file number LO	0x11
Sub-req. 1 starting reg. addr. HI	0x00
Sub-req. 1 starting reg. addr. LO	0x00
Sub-req. 1 register count HI	0x00
Sub-req. 1 register count LO	0x0A
CRC HI	0xB3
CRC LO	0xD4

Rapidus Response	
Slave ID	0x01
Function code	0x14
Byte count	0x16
Sub-req. 1 byte count	0x15
Sub-req. 1 reference type	0x06
Timestamp	XXX
Timestamp	XXX
Timestamp	XXX
Timestamp	XXX
----	
----	
----	
CRC HI	XXX
CRC LO	XXX

The parameters and CRC values in above tables, are as they should be. On the other hand, Rapidus response is given to describe the message structure. As a result, values for variables are not defined.

### 4.5.3.2 Daily archive data

Recording of daily data changes with start of day ([Refer to 3.2.1.2.6.1](#)) setting.

The smallest and largest instantaneous values measured during one day period, are saved as minimum and maximum values. Likewise, average values of measurements, which were taken in one day period, are saved as average values.

14h function operates with file numbers. File numbers 5001 – 5240 are used for DAILY data.

Rapidus has a memory that is reserved for daily files. It can keep totally 240 daily files. When daily memory of Rapidus is filled completely, oldest record is deleted and new record is saved in the deleted record's memory. For more information about record structure of Rapidus, please look at [4.5.3.1 Hourly archive data](#).

The 'last saved file number' inside the daily memory can be accessed from the 32-bit parameter starting from Modbus address 986 for RAPIDUS 231R-E ([Refer to table 4-4](#)) and Modbus address 1034 for RAPIDUS 232R-E ([Refer to Table 4-5](#))

### 4.5.3.3 Monthly archive data

Recording of daily data changes with start of month ([Refer to 3.2.1.2.6.2](#)) and start of day ([Refer to 3.2.1.2.6.1](#)) settings.

The smallest and largest instantaneous values measured during one month period, are saved as minimum and maximum values. Likewise, average values of measurements, which were taken in one month period, are saved as average values.

14h function operates with file numbers. File numbers 10001 – 10036 are used for MONTHLY data.

Rapidus has a memory that is reserved for monthly files. It can keep totally 36 monthly files. When monthly memory of Rapidus is filled completely, oldest record is deleted and new record is saved in the deleted record's memory. For more information about record structure of Rapidus, please look at [4.5.3.1 Hourly archive data](#).

The 'last saved file number' inside the daily memory can be accessed from the 32-bit parameter starting from Modbus address 988 for RAPIDUS 231R-E ([Refer to table 4-4](#)) and Modbus address 1036 for RAPIDUS 232R-E ([Refer to Table 4-5](#))



#### 4.5.4 Clear(Common for RAPIDUS 231R-E and RAPIDUS 232R-E)

Operator/programmer can erase/zeroize data stored in non-volatile memory via MODBUS commands. Erasable data are as follows:

- energy meters
- demand values
- all variables mentioned above
- hourly archive records
- daily archive records
- monthly archive records
- alarm records

Table 4-11 Clear Address Table

Address	Data Type	Parameters/Records to be Cleared	R/W	Value	Modbus func.
1900	32 bit int.	Energy meters	W	1	10H-06H
1902	32 bit int.	Demand values	W	1	10H-06H
1906	32 bit int.	All variables above	W	1	10H-06H
1910	32 bit int.	Hourly archive records	W	1	10H-06H
1912	32 bit int.	Daily archive records	W	1	10H-06H
1914	32 bit int.	Monthly archive records	W	1	10H-06H
1916	32 bit int.	Alarm records	W	1	10H-06H
<b>In order to complete to erase/zeroize, programmer should write 1 to the below MODBUS address:</b>					
1898	32 bit int.	Complete erasing/zeroizing	W	1	10H-06H



In order to complete clearing process, operator/programmer should:

- Write "1" to registers related with 'to be cleared parameters'
- Then, write 0 to 1898 register, and 1 to 1899 register, "within 60 seconds".



**RAPIDUS**

Power Factor  
Controller

**SECTION 5  
FACTORY  
PRESETS**



## SECTION 5 FACTORY PRESETS

	Factory Presets	Unit	Setting Values
<b>Network Settings</b>			
CTR	1	-	1↔5000
VTR	1	-	1.0↔5000.0
Demand Period	15	min	1↔60
<b>Step Settings</b>			
Ent. Power	10	kVAr	0.00↔1000.00
Ent. Type	C	-	C, L, C1, C2, C3, L1, L2, L3, C1-2, C2-3, C3-1, L1-2, L2-3, L3-1 Note: C1-2, C2-3, C3-1, L1-2, L2-3 and L3-1 are available only for 12 step version.
Predefined Structure	1-1-1-1	-	1-1-1-1, 1-1-2-2, 1-2-2-4, 1-2-3-3, 1-2-4-4, 1-1-2-4, 1-2-3-4, 1-2-4-8, 1-1-2-3
Predefined Power	10	kVAr	0.00↔1000.00
Number of Predefined Steps	12	-	1↔12 / 1↔24
Discharge Time	15	s	3↔1000
<b>Compensation Settings</b>			
Steps	Entered	-	Entered, Predefined
Program	Rapidus	-	Rapidus, Ascending Sequential, Descending Sequential, Linear, Circular, Manual
Target 1	1.000	-	-0.800↔0.800
Target 2	0.900	-	0.800↔1.000
Target low limit	0.002	-	0.000↔0.200
Target high limit	0.002	-	0.000↔0.200

	Factory Presets	Unit	Setting Values
Activation Time	10	s	1↔500
Deactivation Time	10	s	1↔500
Shift Angle	0.00	°	-45.00 ↔ 45.00 °
Averaging Time	Off	s	Off, 5 s, 10 s, 20 s, 30 s, 40 s, 50 s, 60 s
Fixed Steps	N/A	-	N/A, Step 1, Step 1 and 2, Step 1,2 and 3
<b>Learn Settings</b>			
Connection	Off	-	Off, On
Step number	1	-	1↔12
Retry Time	5	min	5↔60
Retry Number	3	-	1↔20
Learn Step	Off	-	Off, On
<b>Digital Input Settings</b>			
Mode	Off	-	Off, Night/Day, Generator
<b>Device Settings</b>			
Language	English	-	English, Türkçe, Русский
Contrast	Level 0	-	Level 4↔Level -4
Pass. Protection	On	-	Off, On
New Password	1	-	1↔9999
Display On	Time Dependent	-	Time Dependent, Continuous
Display On Time	600	s	10↔600
<b>Energy Settings</b>			
Start of Day	0	h	0↔23
Start of Month	1		1↔28
kWh	1000000.000	kWh	0.0↔20000000000.0
kWh E.	1000000.000	kWh	0.0↔20000000000.0
kVArh I.	1000000.000	kVArh	0.0↔20000000000.0
kVArh C.	1000000.000	kVArh	0.0↔20000000000.0
<b>Communication Settings</b>			
Baud Rate	38400	bps	2400, 4800, 9600, 19200, 38400, 57600 115200
Slave Id	1	-	1↔247



	Factory Presets	Unit	Setting Values
<b>Alarm Settings</b>			
<b>Energy</b>			
Inductive Hi Limit	20.0	%	0.0↔40.0
Alarm Relay	Off	-	Off, Relay1, Relay2
Capacitive Hi Limit	15.0	%	0.0↔40.0
Alarm Relay	Off	-	Off, Relay1, Relay2
<b>V (L-N)</b>			
Alarm Relay	Off	-	Off, Relay1, Relay2
Low Limit	0.0	V	0.0↔1500000
High Limit	0.0	V	0.0↔1500000
Delay	0	s	0↔600
Hysteresis	0.0	%	0.0↔20
<b>V (L-L)</b>			
Alarm Relay	Off	-	Off, Relay1, Relay2
Low Limit	0.0	V	0.0↔2600000
High Limit	0.0	V	0.0↔2600000
Delay	0	s	0↔600
Hysteresis	0.0	%	0.0↔20
<b>Current, IN</b>			
Alarm Relay	Off	-	Off, Relay1, Relay2
Low Limit	0.0	A	0.0↔30000.0
High Limit	0.0	A	0.0↔30000.0
Delay	0	s	0↔600
Hysteresis	0.0	%	0.0↔20
<b>P</b>			
Alarm Relay	Off	-	Off, Relay1, Relay2
Low Limit	0.0	W	-1000000000.0↔10000000000.0
High Limit	0.0	W	-1000000000.0↔10000000000.0
Delay	0	s	0↔600
Hysteresis	0.0	%	0.0↔20
<b>Q</b>			
Alarm Relay	Off	-	Off, Relay1, Relay2
Low Limit	0.0	VAr	-1000000000.0↔10000000000.0
High Limit	0.0	VAr	-1000000000.0↔10000000000.0
Delay	0	s	0↔600

	Factory Presets	Unit	Setting Values
Hysteresis	0.0	%	0.0↔20
<b>S</b>			
Alarm Relay	Off	-	Off, Relay1, Relay2
Low Limit	0.0	VA	0.0↔10000000000.0
High Limit	0.0	VA	0.0↔10000000000.0
Delay	0	s	0↔600
Hysteresis	0.0	%	0.0↔20
<b>CosØ, PF</b>			
Alarm Relay	Off	-	Off, Relay1, Relay2
Low Limit	0.000	-	0.000↔1.000
High Limit	0.000	-	0.000↔1.000
Delay	0	s	0↔600
Hysteresis	0.0	%	0.0↔20
<b>Step</b>			
Low Limit	20.0	-	20.0↔100.0
<b>F</b>			
Alarm Relay	Off	-	Off, Relay1, Relay2
Low Limit	50.0	Hz	45.0↔65.0
High Limit	50.0	Hz	45.0↔65.0
Delay	0	s	0↔600
Hysteresis	0.0	%	0.0↔20
<b>Harmonics V</b>			
Alarm Relay	Off	-	Off, Relay1, Relay2
THDV Hi Limit	0.0	%	0.0↔100.0
V3 Hi Limit	0.0	%	0.0↔100.0
V5 Hi Limit	0.0	%	0.0↔100.0
V7 Hi Limit	0.0	%	0.0↔100.0
V9 Hi Limit	0.0	%	0.0↔100.0
V11 Hi Limit	0.0	%	0.0↔100.0
V13 Hi Limit	0.0	%	0.0↔100.0
V15 Hi Limit	0.0	%	0.0↔100.0
V17 Hi Limit	0.0	%	0.0↔100.0
V19 Hi Limit	0.0	%	0.0↔100.0
V21 Hi Limit	0.0	%	0.0↔100.0
<b>Harmonics I</b>			
Alarm Relay	Off	-	Off, Relay1, Relay2
THDI Hi Limit	0.0	%	0.0↔100.0

	Factory Presets	Unit	Setting Values
I3 Hi Limit	0.0	%	0.0↔100.0
I5 Hi Limit	0.0	%	0.0↔100.0
I7 Hi Limit	0.0	%	0.0↔100.0
I9 Hi Limit	0.0	%	0.0↔100.0
I11 Hi Limit	0.0	%	0.0↔100.0
I13 Hi Limit	0.0	%	0.0↔100.0
I15 Hi Limit	0.0	%	0.0↔100.0
I17 Hi Limit	0.0	%	0.0↔100.0
I19 Hi Limit	0.0	%	0.0↔100.0
I21 Hi Limit	0.0	%	0.0↔100.0
<b>Temperature</b>			
Alarm Relay	Off	-	Off, Relay1, Relay2
Low Limit	0.0	°C	-20.0 °C ↔55 °C
High Limit	0.0	°C	-20.0 °C ↔55 °C
Delay	0	s	0↔600
Hysteresis	0.0	%	0.0↔20.0



**RAPIDUS**

Power Factor  
Controller

**SECTION 6  
TECHNICAL  
SPECIFICATIONS**

## SECTION 6 TECHNICAL SPECIFICATIONS

### Supply

Voltage(from V1-N)..... 95..272VAC RMS  $\pm 10\%$

Frequency.....45-65 Hz

### Measurement Inputs

CATIII

Voltage..... 95..272VAC  $\pm 10\%$  (L-N)

164..471VAC  $\pm 10\%$  (L-L)

Current..... 0.01..6 A RMS

Frequency..... 45..65 Hz

Night/Day Input..... 95.. 240 VAC RMS

(85..265VAC RMS including tolerances)

### Measurement Accuracy

Function Symbol	Function	Function Performance Class According to IEC 61557-12	Measuring Range	Other Complementary Characteristics
P	Total active power	0,2	$1\% I_n \leq I \leq I_{max}$ 0,5 Ind to 0,8 Cap	-
$Q_V$	Total reactive power	1	$2\% I_n \leq I \leq I_{max}$ 0,25 Ind to 0,25 Cap	-
$S_A$	Total apparent power	0,2	$2\% I_n \leq I \leq I_{max}$	-
$E_A$	Total active energy	0,2	0 to 49999999999	IEC 62053-22 Class 0.25
$E_{rV}$	Total reactive energy	2	0 to 49999999999	IEC 62053-23 Class 2
f	Frequency	0,05	45 – 65 Hz	-
I	Phase current	0,2	$10\% I_n \leq I \leq I_{max}$	-
$I_{Nc}$	Neutral current (calculated)	0,5	$10\% I_n \leq I \leq I_{max}$	-
U	Voltage	0,2	$U_{min} \leq U \leq U_{max}$	-
$PF_A$	Power factor	0,5	0,5 Ind to 0,8 Cap	-
THDV	Total harmonic distortion voltage	1	0 % to 20 %	-
THDI	Total harmonic distortion current	1	0 % to 100 %	-

### Relay Outputs for Compensation

12/24 pcs.,

Max. switching voltage ..... : 250 VAC

Max. switchig current..... : 2 A

### Alarm Relay Outputs:

2 pcs,

Max. switching current.....: 4A

Max. switching voltage .....: 250 VAC

Max. switching power..... : 1250 VA

**Number of Steps**

Can be selected between 1-12/1-24.

**Target Cos $\phi$  Interval**

-0.800-0.800 can be selected with 0.001 steps.

**CTR**

Can be set 1..5000.

**VTR**

Can be set 1..5000.

**Demand Period**

Can be set 1 to 60 minutes.

**User Interface**

Keypad .....: 6 keys with ESD protection

LCD .....: Self-illuminated 160 x 240 graphic

**Communication**

Isolated RS485 Port.....:1 Channel, ESD and over current/voltage protected,  
programmable, 2400bps to 115200 bps baud rate.  
2000VRMS isolation.

**Operating Temperature**

-20°C..+55°C

**Storage Temperature**

-30°C..+80°C

**Relative Humidity**

Maximum 95% No Condensation

**Dimensions**

W144 x H144 x D78

**Protection class**

IP40 front, IP20 rear

**Power Consumption**

<10VA

